

Corbin  
Russwin

ASSA ABLOY

# CK4400 Series

Standard Duty Cylindrical Knob Locksets



ASSA ABLOY, the global leader  
in door opening solutions

# Applications

## CK4400



### Applications

An outstanding combination of value and performance. Ideal for quality residential and light commercial buildings, such as:

- Fine homes
- Apartments
- Motels
- Offices

### Advantages

- Wide array of functions
- Precision manufactured mechanisms, zinc dichromated for corrosion resistance
- Stainless steel latchbolt for long life
- Adjustable latchbolts accommodates flat and beveled doors
- Stainless steel trim available

## Table of Contents

Applications.....	2
Features.....	3
Functions.....	4
Trim Designs.....	5
Options and Accessories .....	6
How to Order .....	8
Helpful Terms .....	10
How to Specify .....	11



### Features

#### Handing

Field reversible.

#### Door Thickness

1-3/8" (35mm) - 1-3/4" (44mm) standard.

#### Backset

2-3/4" (70mm) standard.  
Optional: 2-3/8" (60mm), 3-3/4" (95mm) and 5" (127mm); see How to Order, page 9.

#### Lock Chassis

Steel, zinc dichromated for corrosion resistance.

#### Front

Wrought brass, bronze, or stainless steel, 2-1/4" (57mm) x 1-1/8" (29mm) standard. Accommodates flat doors and doors beveled 1/8" (3mm) in 2" (51mm). Optional fronts available; see How to Order, page 9.

#### Latchbolt

Brass or stainless steel, 1/2" (13mm) throw.

#### Auxiliary Latchbolt

Deadlocking latchbolt prevents manipulation when door is closed.

#### Strike

Wrought brass, bronze, or stainless steel ANSI curved lip standard, 4-7/8" (124mm) x 1-1/4" (32mm) x 1-1/4" (32mm) lip to center. Optional strikes, lip lengths and ANSI wrought strike box available; see How to Order, page 9.

#### Cylinder

Brass, 6-pin L4 keyway, 0-bitted standard.

#### Keying Features Available

Master keying  
Construction master keying

#### Keys

Two nickel silver standard.

#### Warranty

One-year limited.

### Certification/Compliance

#### ANSI

Meets A156.2 Series 4000, Grade 2.

#### Federal

Meets FF-H-106C.

#### UL/ULC

All locks with listed for A label and lesser class single doors, 4' x 8'. Letter F and UL symbol on latch front indicate listing.

Any retrofit or other field modification to a fire-rated opening can potentially impact the fire rating of the opening, and Corbin Russwin, Inc. makes no representations or warranties concerning what such impact may be in any specific situation. When retrofitting any portion of an existing fire-rated opening, or specifying and installing a new fire-rated opening, please consult with a code specialist or local code official (Authority Having Jurisdiction) to ensure compliance with all applicable codes and ratings.

### Finishes

BHMA 605 (US3)	Bright Brass
BHMA 612 (US10)	Satin Bronze
BHMA 613 (US10B)	Oxidized Bronze, oil rubbed
BHMA 629 (US32)	Bright Stainless Steel
BHMA 630 (US32D)	Satin Stainless Steel

Inside rose liner through-bolted to lock chassis to ensure proper alignment and smooth operation

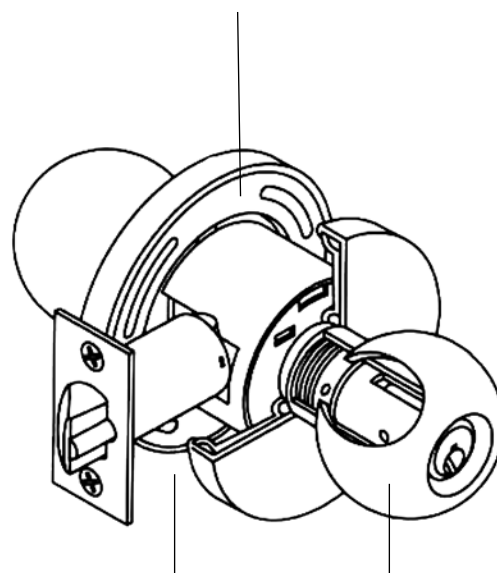

2-3/8" (60mm), 2-3/4" (70mm), 3-3/4" (95mm) and 5" (127mm) backsets available

Knob designs compatible with Corbin Russwin Pre-Assembled Unit Locks, Mortise Locksets, Exit Devices and other Cylindrical Locks

# Functions

## CK4400

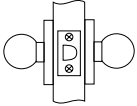
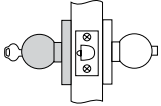
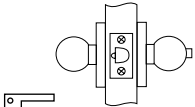
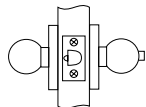
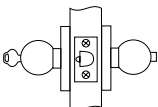
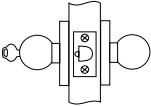
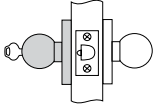
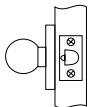
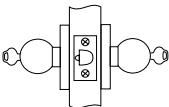
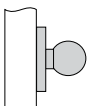
Outside	Inside	Series/Function	Type	ANSI No.	Function Description
		CK4410	Passage or Closet	F75	<ul style="list-style-type: none"> <li>Latchbolt by knob either side.</li> <li>Both knobs always free.</li> </ul>
		CK4429	Hotel or Motel	F93	<ul style="list-style-type: none"> <li>Deadlocking latchbolt by knob inside or by key outside.</li> <li>Push button shuts out all keys except emergency key, and projects occupancy indicator in face of cylinder.</li> <li>Push button released by turning inside knob or by closing door.*</li> <li>Outside knob always rigid.</li> <li>Inside knob always free.</li> </ul>
		CK4430	Privacy, Bedroom or Bathroom	F76	<ul style="list-style-type: none"> <li>Deadlocking latchbolt by knob either side.</li> <li>Outside knob locked by push button.</li> <li>Outside knob unlocked by turning slotted button outside, by rotating inside knob, or by closing door.</li> <li>Inside knob always free.</li> </ul>
		CK4440	Patio or Privacy	F77	<ul style="list-style-type: none"> <li>Deadlocking latchbolt by knob either side, except when push button locks outside knob.</li> <li>Push button released by turning inside knob or by closing door.</li> <li>Inside knob always free.</li> </ul>
		CK4451	Entrance or Office	F81/82	<ul style="list-style-type: none"> <li>Deadlocking latchbolt by knob either side, except when turn button locks outside knob.</li> <li>Pushing turn button in locks outside knob, requiring use of key outside to unlock.</li> <li>Turning inside knob unlocks outside knob.</li> <li>Pushing in and turning button locks outside knob, requiring key at all times. Turning inside knob does not unlock outside knob until button is manually turned to unlocked position.</li> <li>Inside knob always free.</li> </ul>
		CK4455	Classroom	F84	<ul style="list-style-type: none"> <li>Deadlocking latchbolt by knob either side except when key outside locks outside knob.</li> <li>Outside knob unlocked by key outside.</li> <li>Inside knob always free.</li> </ul>
		CK4457	Storeroom or Closet	F86	<ul style="list-style-type: none"> <li>Deadlocking latchbolt by key in outside knob, or by rotating inside knob.</li> <li>Outside knob always rigid.</li> <li>Inside knob always free.</li> </ul>
		CK4480	Communicating or Exit	—	<ul style="list-style-type: none"> <li>Deadlocking latchbolt by knob outside only.</li> <li>Blank rose inside; no inside operation.</li> </ul>
		CK4482	Store Door	F91	<ul style="list-style-type: none"> <li>Deadlocking latchbolt by knob either side, except when key either side locks both knobs.</li> <li>Keyed alike unless otherwise specified.</li> </ul>
		CK4450	Half Dummy Trim	—	<ul style="list-style-type: none"> <li>Knob acts as pull only; no operation.</li> <li>Knob is rigid.</li> </ul>

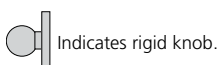

\*Unless push button has been fixed in locked position by spanner key (furnished). When push button is fixed by spanner key, lock is operable only by emergency key or by display key.



### Global

Brass, bronze or stainless steel



### GWC

Knob: Wrought

Rose: Wrought reinforced

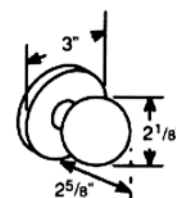

### Belmont

Brass, bronze or stainless steel



### BWC

Knob: Wrought

Rose: Wrought reinforced

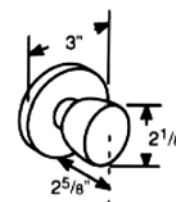

# Options and Accessories

## CK4400

### Latches

Deadlocking feature standard, preventing manipulation when door is closed.  
To order optional latchbolt with lockset, see How to Order, page 9.  
To order latchbolt separately, specify Part No. x Finish (e.g. 574F55 x 626).

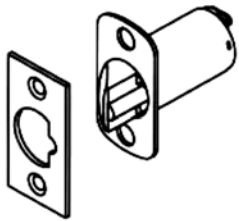

Description	Series/Function	Part NO.
2-3/4" (70mm) Backset	CK4410, CK4451, CK4455, CK4457, CK4480, CK4482	574F55
	CK4429, CK4430, CK4440	574F56
2-3/8" (60mm) Backset	CK4410, CK4451, CK4455, CK4457, CK4480, CK4482	574F29
	CK4429, CK4430, CK4440	574F30

### Extended Backsets

When 3-3/4" (95mm) backset is specified, Extension Unit and Connecting Tube will be furnished for use with 2-3/8" (60mm) backset latch. When 5" (127mm) backset is specified, Extension Unit and Connecting tube will be furnished for use with 2 3/4" (70mm) backset.

To order optional backset with lockset, see How to order, page 9.

To order backset Extension Unit and Connecting Tube, specify Part No. 574F25 for 3-3/4" (95mm) or Part No. 574F26 for 5" (127mm).

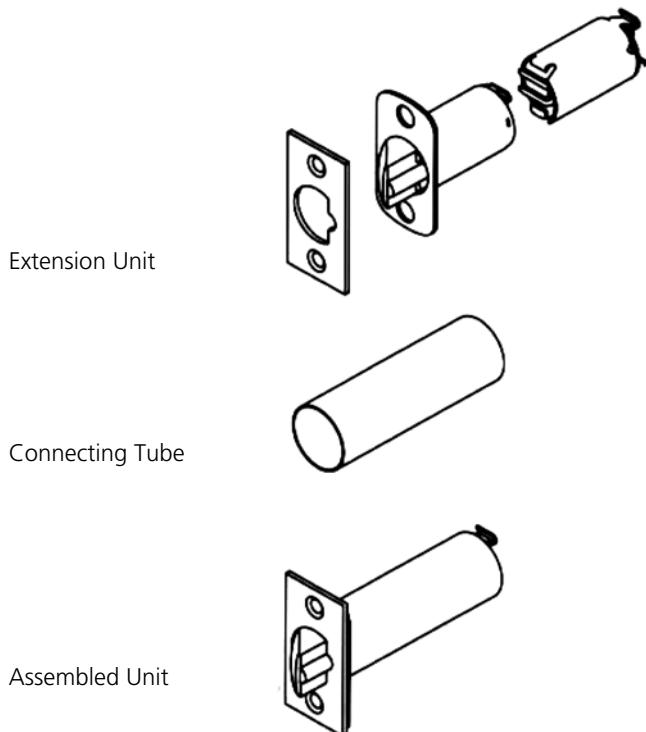

Extension Unit

Connecting Tube

Assembled Unit

# Options and Accessories

CK4400

## Strikes

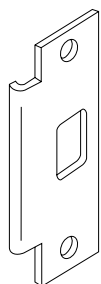

**ANSI Curved Lip** (standard)  
Brass, bronze, or stainless steel, 4-7/8" (124mm) x 1-1/4" (32mm) x 1-1/4" (32mm) lip to center.  
Optional lip lengths: 1" (25mm), 1-1/8" (29mm), 1-3/8" (35mm), 1-1/2" (38mm), 1-3/4" (44mm), 2" (51mm).  
To order separately, specify 217L13 x Lip Length x Finish.

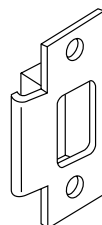

**Curved Lip "T" Strike**  
Brass, bronze or stainless steel  
2-3/4" (70mm) x 1-1/8" (29mm) x 1-1/4" (32mm) lip to center.  
Optional lip lengths: 1" (25mm), 1-1/8" (29mm), 1-3/8" (35mm), 1-1/2" (38mm), 1-3/4" (44mm), 2" (51mm).  
To order optional strike with lockset, see How to order, page 9.  
To order separately, specify 586L19 x Lip Length x Finish.

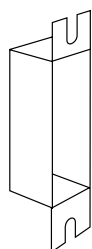

**ANSI Wrought Strike Box**  
To order with lockset, see How to Order, page 9.  
To order separately, specify 120F76-8.

## Tools

**Knob Cover Removal Tool**  
To order, specify 506F57-8.



**Knob Removal Tool**  
To order, specify 574F15-8.



**Cylinder Shell Loading Kit**  
To order, specify CT-10.

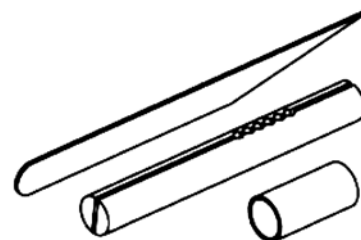

## Cylinders

<p><b>Standard Cylinder</b> .509" plug diameter conventional Brass, 6-pin 2 nickel silver keys Finishes: 606, 619</p>				
Series/Function	All except CK4429	CK4455, CK4482 before August 1993	CK4429 with straight tailpiece	CK4429 with twisted tailpiece
Conventional 6-pin (standard)	2000-044	2003-044	2001-044	2001-066

# How to Order

## CK4400

### Ordering Examples

#### Stock Order

Quantity	Series/Function	Trim	Finish	Hand
100	CK4451	GWC	630	RHR

#### Split Finish Order Privacy function CK4430 only; inside finish 629 only.

Quantity	Series/ Function	Finish			Hand
		Trim	Outside	Inside	
12	CK4430	GWC	605	629	RH

#### Contract / Detailed Order

Quantity	Keyset	Series/ Function	Trim	Finish	Hand	Optional Strike	Backset	Misc. Options	Keying
24	AA1	CK4451	GWC	630	RHR	SA134	B238	M17	VKC1

### Where to find ordering information and quick codes

Series/Function	Page 4
Trim Designs	Page 5
Finish	Page 9
Handing	Page 9
Door Thickness	Page 9
Strike	Page 9
Backset	Page 9
Miscellaneous Options	Page 9
Cylinder and Keying	Page 9



### Cylinder and Keying

Description	Specify
Conventional 6-pin	(standard)
Less cylinder(s)	LC
0-bitted with 2 blank keys	(standard)
Keyed random	KR
Construction master keyed	CMK
Visual key control (VKC)	
Keys only	VKC1
Concealed key control (CKC)	
CKC cylinders with VKC keys	CKC2
CKC cylinders only	CKC3
2 keys per lock	(standard)
More than 2 keys	KY# (e.g., KY6)

### Backset

Description	Specify
2-3/8" (60mm)	B238
2-3/4" (70mm)	(standard)
3-3/4" (95mm)	B334
5" (127mm)	B500

### Finishes

Description	Specify
BHMA 605 (US3) Bright Brass	605
BHMA 612 (US10) Satin Bronze	612
BHMA 613 (US10B) Oxidized Bronze, oil rubbed	613
BHMA 629 (US32) Bright Stainless Steel	629
BHMA 630 (US32D) Satin Stainless Steel	630

### Strikes

Lip to Center	ANSI Curved Lip Specify	Curved Lip Box Specify	Full Lip Specify
1" (25mm)	SA100	SC100	N/A
1-1/8" (29mm)	SA118	SC118	SF118
1-1/4" (32mm)	(standard)	SC114	N/A
1-3/8" (35mm)	SA138	SC138	N/A
1-1/2" (38mm)	SA112	SC112	N/A
1-3/4" (44mm)	SA134	SC134	N/A
2" (51mm)	SA200	SC200	N/A

### Handing

Description	Specify
Right Hand	RH
Left Hand	LH
Right Hand Reverse	RHR
Left Hand Reverse	LHR

### Door Thickness

Door Thickness	Specify
1-1/4" (32mm) - 1-3/4" (44mm)	(standard)

### Miscellaneous Options

Description	Specify
1" latch front, square corners (for 2-3/8" backset only)	M14
ANSI wrought strike box	M17
Abrasive coat outside and inside	M23
Abrasive coat inside	M24
Abrasive coat outside	M25

# Helpful Terms

## CK4400

### **Abrasive Coat**

Hard granular material applied to a knob or lever to provide a non-slip tactile surface for the visually impaired.

### **Auxiliary Latchbolt**

A supplementary latch which, when the door is closed, automatically deadlocks the latchbolt. Protects the latchbolt from forced retraction or "credit carding."

### **Backset**

The distance from the front of the lock to the centerline of the cylinder or knob/lever hub.

### **Bevel**

The angle of the edge of a door in relation to the inside and outside surfaces of the stile. The most common bevel for commercial doors is 1/8" in 2".

### **Box Strike**

A strike equipped with an enclosure behind the hole(s) for the latchbolt and/or deadbolt. Protects the strike area from mortar and cement.

### **Chassis**

The housing of a lockset, containing most of the working parts.

### **Curved Lip Strike**

A strike with the lip curved to conform to the detail of the door frame.

### **Dummy Trim**

Trim only, without the lock or latching mechanism, usually used on the inactive door of a pair of doors for design balance.

### **Front**

The part of a lock visible on the edge of a door.

### **Hand**

The direction a door swings.

### **Latchbolt**

A lock component having a beveled end that projects from the lock front but may be forced back into the chassis by end pressure or drawn back by action of the retractor. When the door is closed, the latchbolt projects into a hole provided in the strike, holding the door in the closed position.

### **Strike**

A metal plate that is pierced or recessed to receive the deadbolt or latchbolt of a lock (sometimes called a keeper).

### **Throw**

The distance that a lock's deadbolt or latchbolt projects when in the locked position. The effective throw is the distance that a latchbolt projects when deadlocked.

### **Wrought Strike Box**

A metal box mounted behind the strike to protect the strike opening from mortar or cement.

### **Keying and Cylinder Terms Construction Master Keying (CMK)**

A cylinder preparation which allows temporary access by construction personnel.

### **Cylinder**

A lock component containing the combination which determines which keys will operate.

### **Key Section**

The cross-section of a key blade, as viewed from bow to tip.

### **Key Symbol**

A letter/number combination in standard industry format (e.g., 1AA, AA1, etc.) which indicates exactly how a key or cylinder fits into a keying system.

### **Keyway**

The opening in a cylinder plug through which the key enters.

### **Master Keying**

Preparation of a cylinder to operate with keys or different levels of access.

### Suggested Specification

All locksets shall be CK4400 Series Standard Duty Cylindrical Knob Locksets as manufactured by Corbin Russwin Architectural Hardware.

Locks shall have a steel chassis with zinc dichromate plated parts for rust resistance.

All knobs and roses shall be of reinforced construction. All inside and outside knobs shall be of the same profile and projection for aesthetic continuity.

All locksets and latchbolts shall be field reversible for ease of installation.

The latchbolt shall be adjustable to accommodate flat or beveled doors, shall have a 1/2" throw and shall include an auxiliary deadlocking feature to inhibit manipulation when door is closed.

All locksets shall be furnished with 2 nickel silver keys. All cylinder plugs shall be furnished with 6-pin chambers for expanded master keying capabilities.

All locksets shall be listed by Underwriters Laboratories for A label and lesser class single doors, 4' x 8'.

Certification:

Federal Specification FF-H-106C

ANSI A156.2 Series 4000, Grade 1

All locks, trim and cylinders shall be from one manufacturer.



**ASSA ABLOY**

**In U.S.**

Corbin Russwin  
Architectural Hardware  
225 Episcopal Road  
Berlin, CT 06037  
Phone: 800-543-3658  
Fax: 800-447-6714  
[corbinrusswin.com](http://corbinrusswin.com)

**In Canada**

ASSA ABLOY Door  
Security Solutions Canada  
160 Four Valley Drive  
Vaughan, Ontario  
Canada L4K 4T9  
Phone: 800-461-3007  
Fax: 905-738-2478  
[www.assaabloy.ca](http://www.assaabloy.ca)

For more information regarding Corbin Russwin Locksets, Exit Devices, Door Controls and Key Systems, contact your authorized Corbin Russwin Distributor or Sales Representative.

Corbin Russwin and Design® is a registered trademark of Corbin Russwin, Inc., an ASSA ABLOY Group company. Other products' brand names may be trademarks or registered trademarks of their respective owners and are mentioned for reference purposes only. These materials are protected under US copyright laws. All contents current at time of publication. Corbin Russwin, Inc., an ASSA ABLOY Group Company, reserves the right to change availability of any item in this catalog, its design, construction, and/or its materials. Copyright © 2003, 2011 Corbin Russwin, Inc., an ASSA ABLOY Group company. All rights reserved. Reproduction in whole or in part without the express written permission of Corbin Russwin, Inc. is prohibited.

ASSA ABLOY is the global leader in door opening solutions, dedicated to satisfying end-user needs for security, safety and convenience.