

Automatic Door Opener

RIXSON[®]
ASSA ABLOY

Low Energy Opener
For Entries with Existing
or New Floor Closers



ASSA ABLOY, the global leader in door opening solutions

Introduction

When a floor closer is the way to close the door but, the convenience of an automatic opener is required, Rixson 2900 is the perfect solution.

- Surface mounted overhead low energy operator
 - No need for special power supply (120 volt input)
 - No need for railing systems
- Opener only — door is hung and closed by a floor closer
 - This allows all the features of the floor closer to be utilized when the door is automated
- Can be used on new installations or on existing floor closer installations that need to be automated
- Order opener and closer separately

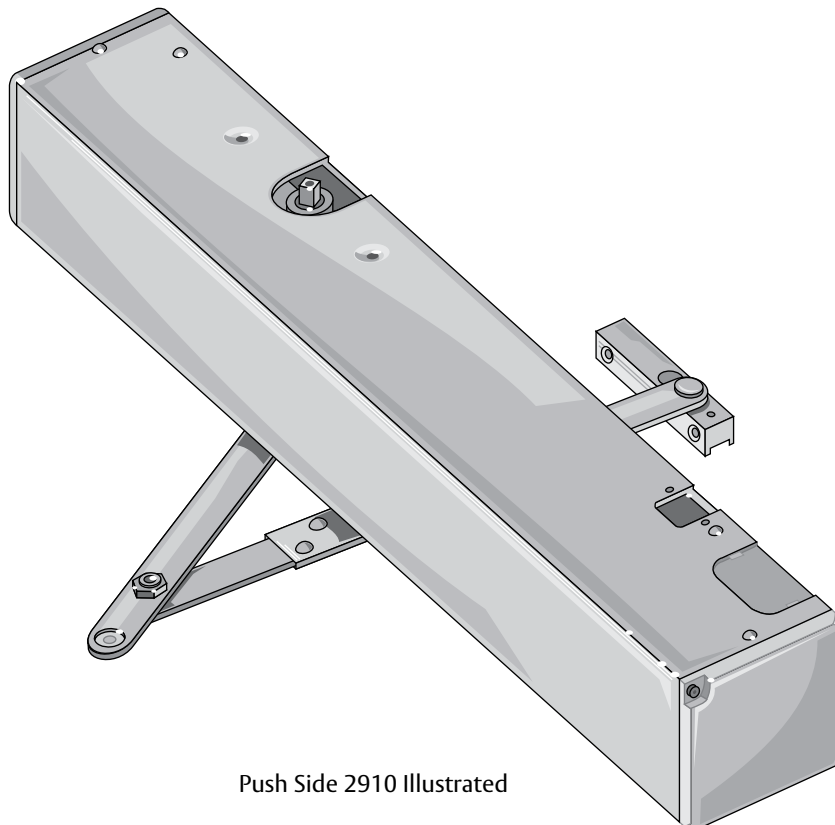

Push Side 2910 Illustrated

Contents	Page
Automatic Door Opener: General Information	232
Options	234
Certifications	234
Limited Warranty	234
Specifications	235
2920 Automatic Opener Pull Side Mount.....	236
2925 Automatic Opener Pull Side Mount x Double Egress	236
2910 Automatic Opener Push Side Mount.....	236
2915 Automatic Opener Push Side Mount x Deep Reveal.....	236
2910-D Automatic Opener Push Side Mount x Drop Plate	236
2915-D Automatic Opener Push Side Mount x Drop Plate x Deep Reveal.....	236
Technical Details	238
Accessories	240
Parts Drawings	242
How to Order	244

Automatic Door Opener Options, Certifications Limited Warranty

Options

The Rixson® 2900 is a “low energy” power door operator designed to automatically open the door with a lower energy opening force. The appropriate floor closer will control the door closing functions.

The American with Disabilities Act (ADA) is a law administered by the U.S. Department of Justice. Its guidelines under ADA Regulation for Title III are detailed on the ADA website: www.ada.gov.

The Rixson® 2900 aids in complying with ADA and ANSI A156.19 requirements. It functions using an A/C motor and hydraulic pump to activate a heavy-duty floor closer. The Rixson® 2900 is your best choice in a low energy power door operator with its:

Ease of installation and setup

- Simple instructions
- Uses push-button settings for door open positions

Application versatility and ease of adjustment

- Handed units
- Push side or pull side mounted units available
- Interfaces with electrified hardware and integrates with access control systems

Allows the floor closer to act normally during close cycles or if power is turned off

- Spring force provides the feel of a normal manual door closer
- Door can be opened manually if desired

Operation startup options

- Wall switches
- Motion sensor
- Radio frequency transmitter
- Push and Go

Hold Open options

- 0-30 seconds (5 seconds minimum required for ADA and ANSI A156.19)
- Choice of indefinite hold open feature

Obstruction detection

- Door closes if it hits an obstruction while opening
- Door re-opens once if it hits an obstruction while closing

FUNCTIONS

- Push Side or Pull Side Applications
- Open/Close Obstruction Detection
- Motor Startup Delay adjustment
- Vestibule Function Delay adjustment (For sequencing two or more units)
- Door Hold Open Delay adjustment
- Single Pole Double Throw (SPDT) Relay Output
- SPDT Relay Output time is adjustable and shall not exceed 1amp @ 30VDC
- SPDT Alarm Output
- Indefinite Hold Open function
- Presence Detector Input
- 24 VDC @ 500 mA Auxiliary Output
- Power input 120VAC 60HZ (+10% -15%)
- Current draw 1.5 amp
- Selector Mode Switch (3 position)
 - OFF – Turns unit off. Disables all functions except smoke ventilation
 - ON – Turns unit on
 - HOLD OPEN – Activates the unit to the hold open position indefinitely

Certifications

Rixson® low energy openers are in compliance with ANSI/BHMA 156.19 Standards. See individual products for sub sections.



Limited Warranty

Rixson® 2900 Power Openers are warranted for 2 years for defect. See Rixson® Price Book for specific details of the limited warranty.

Specifications

Heavy-weight, high traffic doors that require automatic opening shall use the low energy operator in conjunction with a heavy-duty floor closer. Operator shall be for opening of door only.

Door closer shall be installed in the floor and shall have separate and independent closing speeds with backcheck turned to lightest setting.

Door controls (interior/exterior) for swinging doors shall be low energy operators. Low energy operation to cycle the door open as controlled by the body/pump and motor assembly adjustments. Floor closer unit shall provide conventional door closer opening forces unless the power operator motor is activated by an initiating device. Motor assist shall be adjustable from 0 to 30 seconds in 5 second increments. Motor assist shall restart the time cycle with each activation of the initiating device. Unit shall have a three-position selector mode switch that shall permit unit to be switched "ON" to monitor for function activation, switched to "H/O" for indefinite hold open function or switched to "OFF," which shall deactivate all control functions (except smoke ventilation function) but will allow standard door operation by means of the floor closer. Door opening shall be adjustable to provide compliance with the requirements of the Americans with Disabilities Act (ADA) and ANSI standards A117.1 and A156.19.

All openers to have push button controls for setting door open position. All openers to have open obstruction detection and close obstruction detection built into the unit. All openers to have motor start-up delay, vestibule interface delay, electric lock delay and door hold open delay up to 30 seconds. All openers to have inputs for smoke ventilation doors, which allow doors to power open upon fire alarm activation and hold open indefinitely or until fire alarm is reset. All openers to have a presence detector input to prevent a closed door from opening or a door that is fully opened from closing. All openers to have a hold open toggle input to allow remote activation for indefinite hold open; door closes the second time the input is activated. All openers to have vestibule inputs to allow sequencing operation of two units. All openers to have a 24VDC @ 500mA output for controlling electric strikes, electromagnetic locks or radio frequency receivers. All openers to have an SPDT relay for interfacing with latch retraction exit devices, electric strikes, etc. All openers to be hard wired with power input of 120VAC @ 60HZ.

Automatic Door Opener Standard and Drop Plate Applications

Standard Applications

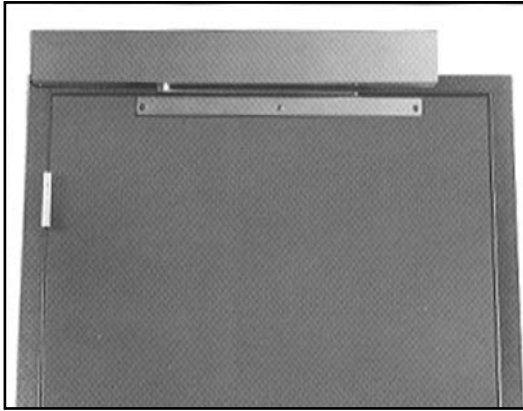

RH Shown

2920/2925

Hinge (Pull) Side of Door

- Spring-buffered stop assembly in slide track

2920 Rigid Arm and Slide Track

- 1/8" (3mm) maximum frame reveal

2925 Double Egress Arm and Slide Track

- From 1/8" to 3" (3 to 76mm) frame reveal
- Specify hand when ordering

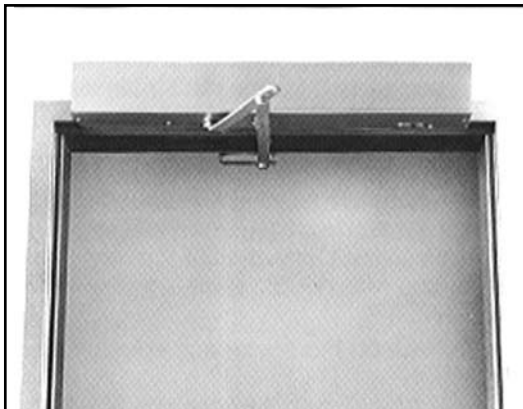

LH Shown

2910/2915

Stop (Push) Side of Door

Heavy-Duty Double Lever Arm

- Maximum frame reveals as charted
- Spring-buffered stop in arm shoe assembly

SERIES	REVEAL RANGE	
2910	2-1/4" to 4-3/4"*	(57 to 121mm)*
2915	4-13/16" to 7-3/8"	(122 to 187mm)

* Reveals less than 2-1/4" (57mm) may be achieved by field cutting the adjusting rod

NOTE: Maximum door opening degree determined by floor closer.

Drop Plate Applications

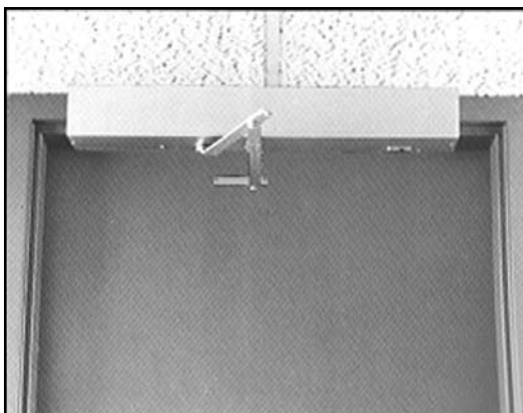

LH Shown

2910-D/2915-D

Stop (Push) Side of Door

Heavy-Duty Double Lever Arm

- Maximum frame reveals as charted
- Spring-buffered stop assembly in arm shoe

SERIES	REVEAL RANGE	
2910-D	2-1/4" to 4-3/4"*	(57 to 121mm)*
2915-D	4-13/16" to 7-3/8"	(122 to 187mm)

* Reveals less than 2-1/4" (57mm) may be achieved by field cutting the adjusting rod

NOTE: Door opening degree determined by floor closer.

Standard Applications

Pivot Point
 30-3/16" (767mm)
 31-11/16" (805mm)
 2" (51mm) Min.
 4-1/2" (114mm)
 4-3/8" (111mm)
 4-7/8" (124mm)
 "S"
 23" (584mm)

SERIES	DIM "S"
2920	1-3/4" (44mm)
2925	2-3/4" (70mm)

2920 Rigid Arm
2925 Double Egress Arm (Handed)

DOOR SWING	85°	90°	95°	105°
MINIMUM DOOR WIDTH (mm)	32" (813)	31" (787)	30" (762)	29" (737)

Minimum door width for all double egress applications is 29" (737mm).

31-11/16" (805mm)
 1-1/2" (38mm) Min.
 4-1/2" (114mm)
 4-3/8" (111mm)
 4-1/8" (105mm)
 2-3/16" (56mm)

DOOR SWING	85°	90°	95°	105°
MINIMUM DOOR WIDTH (mm)	34" (864)	33" (838)	33" (838)	32" (813)

2910
2915

DOOR SWING	85°	90°	95°	105°
MINIMUM DOOR WIDTH (mm)	34" (864)	33" (838)	33" (838)	32" (813)

Minimum door width for all double egress applications is 29" (737mm).

Drop Plate Applications

31-11/16" (805mm)
 1-1/2" (38mm) Min.
 4-1/2" (114mm)
 4-3/8" (111mm)
 1-7/8" (48mm) Min.
 3-7/8" (98mm)

Drop Plate

DOOR SWING	85°	90°	95°	105°
MINIMUM DOOR WIDTH (mm)	36" (914)	35" (889)	34" (864)	33" (838)

2910-D
2915-D

DOOR SWING	85°	90°	95°	105°
MINIMUM DOOR WIDTH (mm)	36" (914)	35" (889)	34" (864)	33" (838)

Minimum door width for all double egress applications is 29" (737mm).

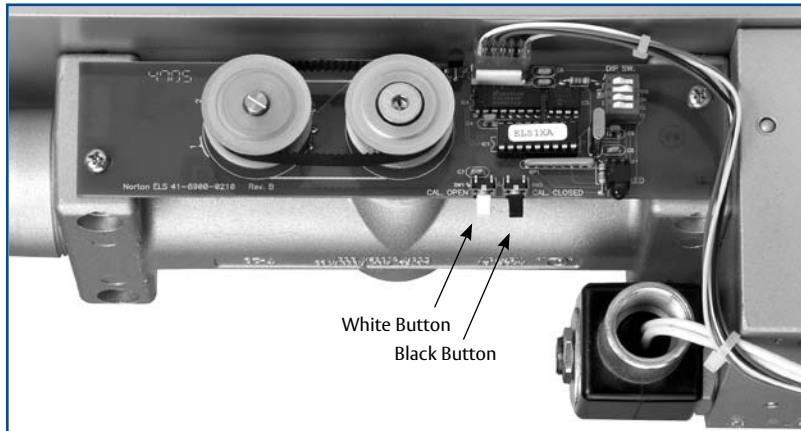
Technical Details**ELS – Electronic Limit Switch:**

Used for open door setting, Push and Go selection, obstruction timing and Power Operator/Power Assist Function.

- WHT Button – Used for Door Open setting
- BLK Button – Used for Door Closed setting

Dip Switch Settings

- 1 - Obstruction Detection Delay
- 2 - Obstruction Detection Delay
- 3 - Aviation Mode (Push and Go)
- 4 - Power Assist/Power Operator Mode

See Close-up on pg 239

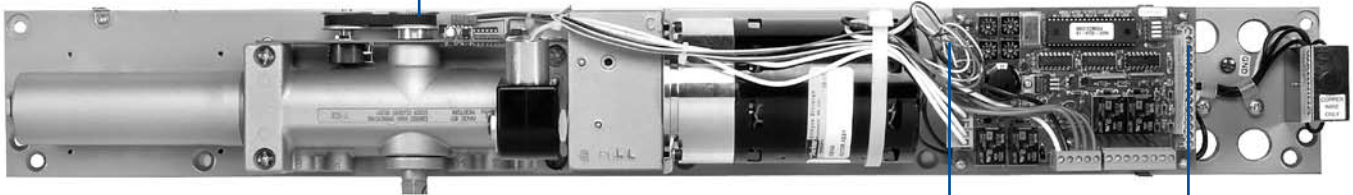
**SW1 Dip Switches**

- 1 - P/A – **Door Operator Function Switch** - OFF position selects Operator Mode. ON position selects the Assist Mode.
- 2 - A/D – **Alarm Delay Timer** – OFF = 30 second delay. ON = 60 second delay. Used with terminal JP1-1
- 3 - Not used – OFF
- 4 - Not used – OFF

**Timer Adjustments**

- SW2 – **Motor Delay** – Delays motor start-up to allow unlocking of electric hardware.
- SW3 – **Solenoid Delay** – Sets the length of time that the relay will stay energized or de-energized. Used for JP4-3, 4 and 5 relay. Allows electric hardware to stay energized long enough for automatic door opening.
- SW4 – **Vestibule Delay** – Sets the length of time between receipt of the IN Vestibule signal and the motor start-up.
- SW5 – **Hold Open Delay/Assist Delay** – Sets length of time door holds open at the fully open position for operator function. Sets length of time motor and pump assembly will operate to reduce opening force of door for assist function. When time elapses the door will operate as a standard door closer.

Technical Details

2900 Control Board JP-1 Terminal: (Input Controls) – wall switches, motions sensors, 2nd Rixson 2900, etc.

- 1 - O/O – **Override Open** – Input for blow open or smoke ventilation application - Upon initiation of a closed signal from a fire/smoke alarm panel, the door will open and remain open until signal is terminated. Use with any JP-1 ground.
- 2 - RES 1 – Not used
- 3 - AUX2 – **Auxiliary Two** – This is one of two secondary initiating switch input contacts. (JP-10 is the other.) Use with any JP-1 ground to initiate operation.
- 4 - GND – **Ground**
- 5 - INV – **IN Vestibule** – Used for vestibule function. This contact must be connected to the JP-1-6 terminal from another unit to receive an initiating signal. Use this contact with any JP-1 ground.
- 6 - OUTV – **Out Vestibule** – Used for vestibule function - This contact must be connected to terminal JP-5 of another unit to send an initiating signal. Use this contact with any JP-1 ground.
- 7 - GND – **Ground**
- 8 - RFT – **Toggle (Maintained Hold Open)** – This input can be used with any normally open switch. The first initiation of this contact will open door and hold it open. A second initiation of this contact will release and close the door. Use with any JP-1 ground.
- 9 - GND – **Ground**
- 10 - AUX2 – **Auxiliary Two** – Same as JP1-3 above.
- 11 - GND – **Ground**
- 12 - PDET – **Presence Detector** – Permits wiring of a sensor to prevent a closed door from opening or a door that is fully open from closing. Use with any JP-1 ground.
- 13 - GND – **Ground**
- 14 - AUX1 – **Auxiliary One** – Primary initiating switch contact. Initiates door power cycle. For vestibule function, the switch on the initiating side of door is connected to this terminal. Use with any JP-1 ground.

JP-4 Terminal: (Output Controls) – electric strikes, latch retraction exit devices, mag locks, etc.

- 1 - GND – **Ground**
- 2 - +24VDC
- 3 - NO1 – **Relay Contact** – Normally open relay dry contact that is switched when any auxiliary inputs are initiated. Delay can be set for up to 12 seconds. Use with JP4-4 CO-1.
- 4 - CO1 – **Relay Contact** – Common relay contact for use with terminals JP4-3 and JP4-5.
- 5 - NC1 – **Relay Contact** – Normally closed relay contact that is switched when any auxiliary inputs are initiated. Delay can be set for up to 12 seconds. Use with JP4-4 CO1.
- 6 - NO2 – **Alarm Delay** – Normally open dry relay contact that is switched when any auxiliary inputs are initiated. The relay will stay switched for 30 or 60 seconds ().
- 7 - CO2 – **Alarm Delay** – Common contact for use with terminals JP4-6 and JP4-8.
- 8 - NC2 – **Alarm Delay** – Normally closed dry contact that is switched when any auxiliary inputs are initiated. The relay will stay switched for 30 or 60 seconds ().

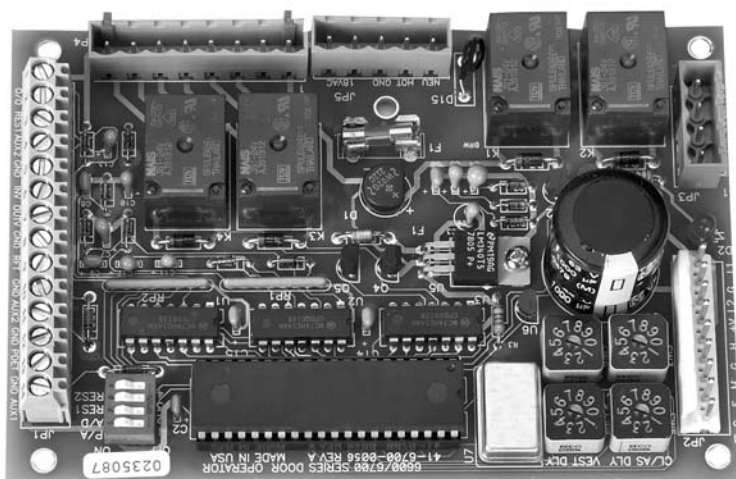

Accessories**#29679 Operational Signs**

(Packaged with unit) – Supplied with 2900 Operator



#29425 (1 per)



#29426 (1 per)



#29427 (2 per)



#29431 (1 per)



#29430 (1 per)



#29428 (2 per)

Motion Sensor #29663

- Uni-directional
- Black cover
- SPDT relay
- Adjustable angle pattern
- 24 VDC input
- Must not be placed where motion of door can be sensed

Switch Post #29677

- 6"W x 4"D x 40"H x 3/16" wall thickness
- Durable exterior grade powder coat 42" high
- Finish in gray or dark bronze. Specify when ordering
- Standard formed plastic cap (2" high)
- Surface mounted (above ground)
- Radio Frequency Transmitter included (4" x 4" face plate)

Switch Post #29678

- 6"W x 4"D x 40"H x 3/16" wall thickness
- Durable exterior grade powder coat 42" high
- Finish in gray or dark bronze. Specify when ordering
- Standard formed plastic cap (2" high)
- Surface mounted (above ground)
- Switch included (4" x 4" face plate)

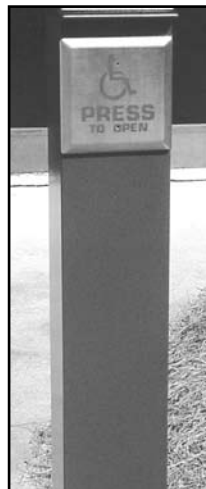
**#29681 Signage Kit**

(Packaged with 29661, 29662, 29669, 29673, 29675, 29684, 29685, 29686 switches)



#29429 (1 per switch)

Supplied with wall switches

#29682 Signage Kit

(Packaged with 29660, 29672, 29674, 29676 switches)



#29432



#29433

(1 per switch) (1 per switch)

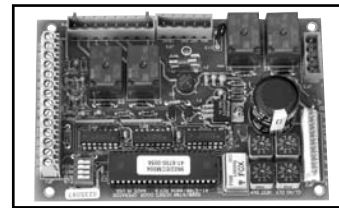
Miscellaneous Parts

#296700PCB – Control Board

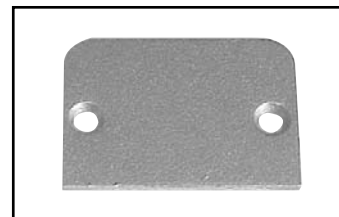

#29668 Security Plate – Conceals the ON/OFF/HOLD OPEN switch to deter tampering. Packed standard with the Rixson 2900.

Note: For additional accessories consult factory.

Accessories

Activating Door Switches



29660



29661

29660, 29661

4" x 4" Face Plate

- 4-1/2" x 4-1/2" SS Back Plate
- 15 amp @ 125VAC
- Flush Mounted – Hard Wired
- Fits single or 2 gang electrical box
- **29660** – Stainless Steel with Black Letters
- **29661** – Blue Powder Coat with White Letters



29574



29576

29574RF, 29576RF, 29685HW, 29575HW

6" x 6" Face Plate

- Stainless Steel with Blue Letters
- 29574 – Flush Mounted - Wireless used with RF1 option and 29671 kit

* Requires that the unit be equipped with Radio Frequency Receiver (RF1 suffixed units) or purchased with a 29671 conversion kit.



29662



29672

29662, 29672

1-11/16" x 4-1/2" Face Plate

- 1-11/16" x 4-1/2" Back Plate
- SPDT UL listed Switch-Mom.
- 15 amp @ 125VAC
- Fits 1 -3/4" Frame
- **29662** – Stainless Steel with Red Button
- **29672** – Stainless Steel with Black Letters

Note: All hard-wired switches are Momentary Contact SPDT, UL Listed.



RF1 – Radio Frequency Option with Door Opener

29687 kit ordered separately

A Radio Frequency receiver used to control the Rixson 2900 from a remote location. Wireless. (Factory wired and mounted).

Actuators ordered separately:

- 26572RF
- 26581RF
- 26383RF
- 29574RF
- 29576RF
- 29577RF

Transmitters

- 9 volt battery
- Temperature: -4° F to 122° F
- Used with RF1



26572 – Key Fob

- 1-1/2"w x 2-3/16"h x 9/16" d
- Two channel



26581

- 2-3/8"w x 4-3/16"h x 15/16"d
- Single channel



26582

- 2-3/8"w x 4-3/16"h x 15-16"d
- Two channel

Body Pump and Motor Assemblies

Right Hand Body Pump and Motor Assembly
292LAP-R (2920, 2925)
291LAP-R (2910, 2915)
Left Hand Body Pump and Motor Assembly
292LAP-L (2920, 2925)
291LAP-L (2910, 2915)
PC Board 296700PCB

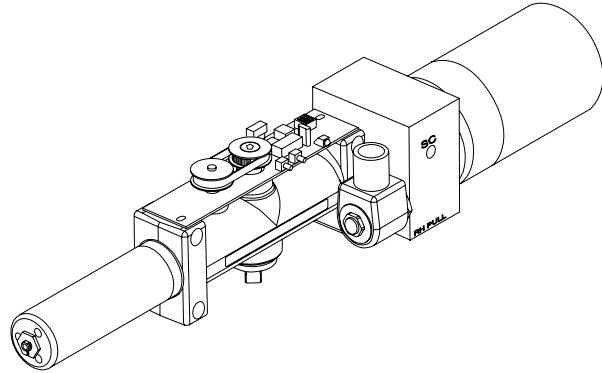
**Arm and Track Assemblies**

(A)	Arm and Track Assembly 2926610-1
	Arm Assembly 297210-1Arm
	296610-1Track

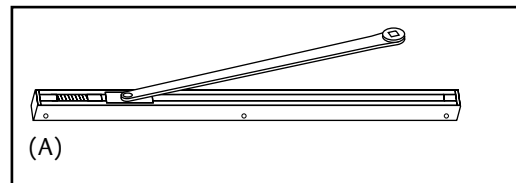

(B)	Arm and Track Assembly (LH) 296650-1L
	Arm and Track Assembly (RH) 296650-1R
	Arm Assembly 297250-1L (LH)
	Arm Assembly 297250-1R (RH)
	Track Assembly 296610-1T

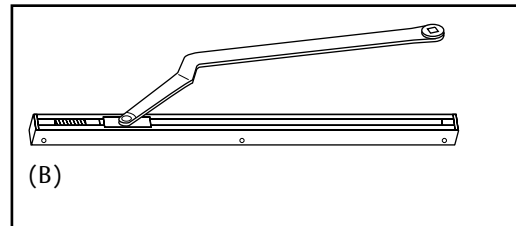

(C)	Arm Assembly 296660-1
	Rod & Snubber Assembly 296660-11

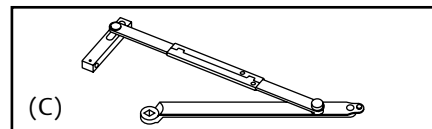

(D)	Arm Assembly 296670-1
	Rod & Snubber Assembly 296670-11

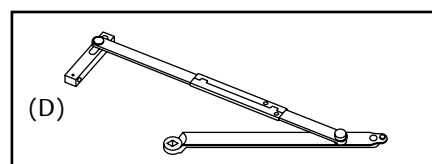

RFI Kit 29671

2900 Cover

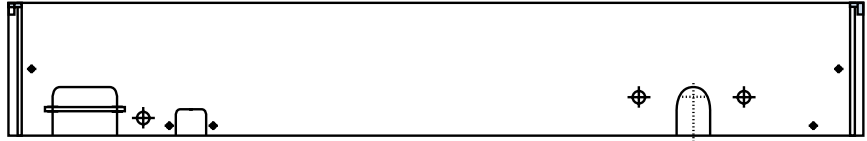

41-6900-0914

Drop Bracket 2910-15DPL

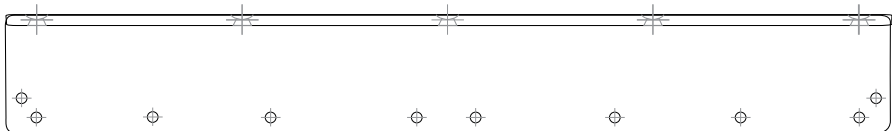

41-6900-0913

How to Order