



# 4700(LN) Series

Grade 1 Cylindrical Locks

## introduction

Yale® 4700(LN) cylindrical locks are the ideal choice for a wide variety of commercial applications where consistent quality, ease of use and installation are required at an economical price. The 4700(LN) Series is certified to ANSI/BHMA Grade 1 standards and is UL fire-listed for all functions ensuring reliability and peace of mind.

### A.D.A.

The 4700LN lever designs meets accessibility guidelines of the Americans with Disabilities Act and the requirements of the Uniform Federal Accessibility Standards and ANSI A117.1, all requiring ease of accessibility for the handicapped.

### ANSI/BHMA

Certified ANSI/BHMA A156.2, Series 4000 Grade 1.



### backset

The 4700(LN) series cylindrical locksets are available with a 2-3/4" (70mm) standard backset.

### door thickness

For 4700LN levers, patented (patent no. 6,131,970) door adjustable rose support plates allow the 4700LN to easily adjust to doors from 1-3/4" (44mm) to 2" (51mm) thick. For 1-3/8" (35mm) or 2-1/4" (57mm) thick doors, please specify door thickness on order.

4700 knobs adjustable for doors 1-3/4" (44mm) to 2" (51mm).

### free wheeling lever trim



All 4700(LN) Series locking functions feature the Free Wheeling lever mechanism. When the outside lever is locked, it will rotate freely up and down while remaining securely locked.

### installation

Fits ANSI/BHMA A156.115, which covers Hardware Preparation in Steel Doors and Frames and ANSI/ BHMA A156.115-W for Wood Doors with Wood or Steel Frames.

### latchbolts

2-3/4" (70mm) backset, 1/2" (13mm) throw latchbolt deadlocking or plain supplied standard. See page 11 for optional latchbolts.

### fire listings

4700(LN) Series locksets are UL - cUL listed for use on fire doors having a rating up to and including 3 hours.

Note: Any retrofit or other field modification to a fire rated opening can potentially impact the fire rating of the opening, and Yale Locks & Hardware makes no representations or warranties concerning what such impact may be in any specific situation. When retrofitting any portion of an existing fire rated opening, or specifying and installing a new fire-rated opening, please consult with a code specialist or local code official (Authority Having Jurisdiction) to ensure compliance with all applicable codes and ratings.

### strikes

ANSI strike 4-7/8" x 1-1/4" x 1-1/4" (124mm x 32mm x 32mm) lip to center supplied standard. See page 12 for optional strikes.

### knurled lever designs

Where required by the local authority, 4700LN series trim can be knurled to be identifiable to the touch for blind persons. All lever designs in all finishes, with the exception of 612, may be ordered knurled. Only the outside lever will be knurled unless specified otherwise. To order, suffix the lockset model number with "Knurled", i.e. 4707LN x Knurled.

## contents

Introduction . . . . .	2
Trim Designs . . . . .	3
Functions . . . . .	4-6
SecureX® . . . . .	7
SecureX® Accessories . . . . .	8
Cylinders . . . . .	9-10
Latchbolts . . . . .	11
Strikes . . . . .	12
How to Order . . . . .	13

## finishes

ANSI/BHMA Code	Finish Description
605	Bright Brass, Clear Coated (Lever Only)
606	Satin Brass, Clear Coated (Lever Only) <sup>1</sup>
612	Satin Bronze, Clear Coated (Lever Only)
613	Dark Oxidized Satin Bronze, Oil Rubbed (Lever Only) <sup>2</sup>
625	Bright Chrome Plated (Lever Only)
626	Satin Chrome Plated (Lever Only) <sup>1</sup>
630	Satin Stainless Steel (Knob Only)
722	Black Oxidized Bronze, Oil Rubbed <sup>3</sup>

1. Cylinders provided in these finishes only.
2. New May 1, 2010
3. Formerly 613 prior to May 1, 2010

## handing

Locksets are non-handed and easily field reversible.

## windstorm

4700LN certified (refer to local codes).



Hurricane

## warranty

The 4700(LN) series cylindrical locks carry a five-year mechanical warranty.

## trim designs

### levers

#### Augusta AU

Lever: Cast Zinc  
Rose: Wrought Brass

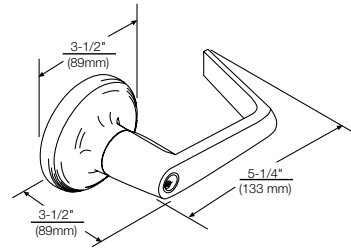

#### Monroe MO

Lever: Cast Zinc  
Rose: Wrought Brass

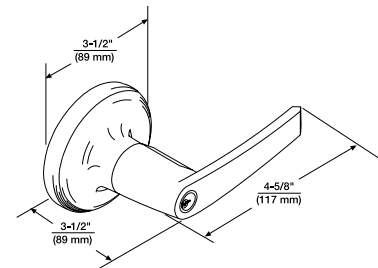

#### Pacific Beach PB

Lever: Cast Zinc  
Rose: Wrought Brass

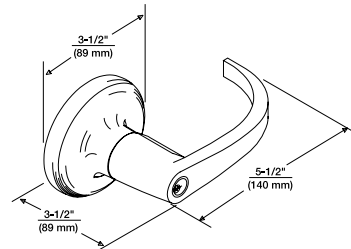

### knob

#### Carolina CA

Knob: Stainless Steel  
Rose: Stainless Steel

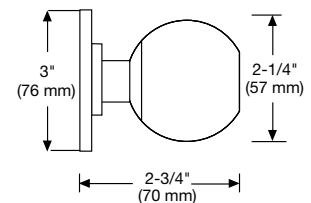

All levers available with interchangeable core. Knob available with small format interchangeable core only. See page 9-10 for details.

Dimensions shown are in inches (mm).

## functions

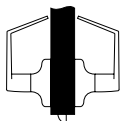
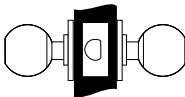
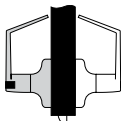
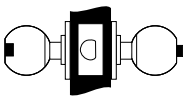
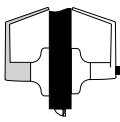
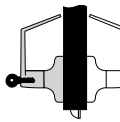
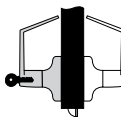
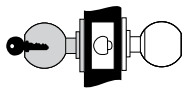
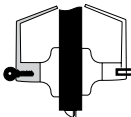
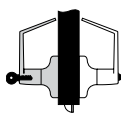
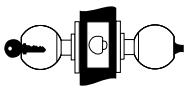
<p><b>4701LN (F75)</b></p> <p><b>Passage or Closet Latch</b></p> <ul style="list-style-type: none"> <li>For doors that do not require locking.</li> <li>Either lever operates latchbolt at all times.</li> </ul>  <p>Outside    Inside</p>	<p><b>4701 (F75)</b></p>  <p>Outside    Inside</p>	<p><b>4702LN (F76A)</b></p> <p><b>Privacy, Bedroom or Bath Lock</b></p> <ul style="list-style-type: none"> <li>For lavatory or other privacy doors.</li> <li>Either lever operates latchbolt unless outside lever is locked by pushbutton inside.*</li> <li>Button automatically releases when inside lever is turned or door is closed.</li> <li>Emergency key inserted and turned in hole in outside lever will unlock door from outside. (Emergency key furnished with lockset.)</li> <li>Inside lever always active.</li> </ul>  <p>Outside    Inside</p>	<p><b>4702 (F76A)</b></p>  <p>Outside    Inside</p>
<p><b>4703LN (F77A)</b></p> <p><b>Patio or Privacy Lock</b></p> <ul style="list-style-type: none"> <li>For exit doors with limited entry.</li> <li>Deadlocking latchbolt.</li> <li>Either lever operates latchbolt unless outside lever is locked by pushbutton inside.*</li> <li>Button automatically releases when inside lever is turned or door is closed.</li> <li>Inside lever always active.</li> </ul>  <p>Outside    Inside</p>	<p><b>4704LN (F82A)</b></p> <p><b>Entry Lock</b></p> <ul style="list-style-type: none"> <li>For entrance or office doors.</li> <li>Deadlocking latchbolt.</li> <li>Either lever operates latchbolt (except when outside lever is locked from inside).*</li> <li>Pushing button in inside lever locks outside lever. (Automatically releases when inside lever is turned or key is rotated in locked outside lever.)</li> <li>Latchbolt is operated by key in outside lever or by rotating inside lever.</li> <li>Inside lever always active.</li> </ul>  <p>Outside    Inside</p>	<p><b>4705LN (F86)</b></p> <p><b>Storeroom or Closet Lock</b></p> <ul style="list-style-type: none"> <li>For use on storeroom, utility, exit doors.</li> <li>Deadlocking latchbolt.</li> <li>Latchbolt operated by lever inside, key in outside lever.</li> <li>Outside lever always locked.*</li> <li>Inside lever always active.</li> </ul>  <p>Outside    Inside</p>	<p><b>4705 (F86)</b></p>  <p>Outside    Inside</p>
<p><b>4706LN (F92)</b></p> <p><b>Service Station Lock</b></p> <ul style="list-style-type: none"> <li>Deadlocking latchbolt.</li> <li>Either lever operates latchbolt.</li> <li>Pushbutton in inside lever locks outside lever. (Automatically releases when inside lever is turned, door is closed or key is rotated in outside lever, except when slotted pushbutton is rotated 90° clockwise to retain outside lever in locked position.)*</li> <li>Latchbolt operated by key in outside lever, inside lever always active.</li> </ul>  <p>Outside    Inside</p>		<p><b>4707LN (F109)</b></p> <p><b>Entry Lock</b></p> <ul style="list-style-type: none"> <li>For entrance, general home or office doors.</li> <li>Deadlocking latchbolt.</li> <li>Either lever operates latchbolt (except when outside lever is locked from inside).*</li> <li>Pushing turn button in inside lever locks outside lever. (Automatically releases when inside lever is turned or key is rotated in locked outside lever.)</li> <li>Outside lever may be retained in locked position by pushing and rotating turn button 90° clockwise to a horizontal position; not released until turn button is manually returned to the vertical position.</li> <li>Latchbolt is operated by key in outside lever or by rotating inside lever.</li> <li>Inside lever always active.</li> </ul>  <p>Outside    Inside</p>	<p><b>4707 (F109)</b></p>  <p>Outside    Inside</p>

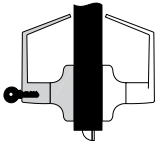
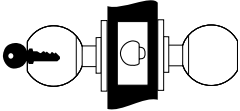
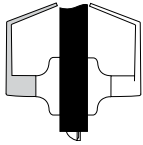
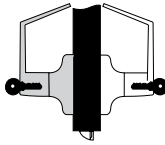
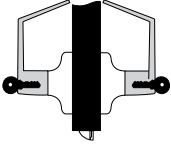
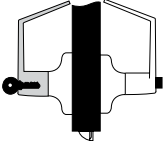
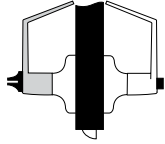
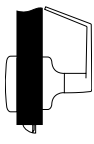
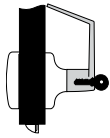
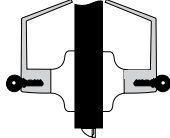

\* Lever handles are Free-Wheling in locked position. Shaded area denotes FreeWheling lever or rigid knob.

functions

<p><b>4708LN (F84)</b></p> <p><b>Classroom Lock</b></p> <ul style="list-style-type: none"> <li>• For classroom or utility room doors.</li> <li>• Deadlocking latchbolt.</li> <li>• Either lever operates latchbolt (except when outside lever is locked by key).*</li> <li>• Inside lever always active.</li> <li>• Key releases outside lever.</li> </ul>  <p>Outside    Inside</p>	<p><b>4708 (F84)</b></p>  <p>Outside    Inside</p>	<p><b>4709LN (F89)</b></p> <p><b>Exit Latch</b></p> <ul style="list-style-type: none"> <li>• For exit doors with no-entry desired.</li> <li>• Deadlocking latchbolt.</li> <li>• Outside lever always locked.*</li> <li>• Inside lever always active.</li> </ul>  <p>Outside    Inside</p>	<p><b>4718LN (F110)</b></p> <p><b>Intruder Classroom Lock</b></p> <ul style="list-style-type: none"> <li>• For classroom doors.</li> <li>• Deadlocking latchbolt.</li> <li>• Either lever operates latchbolt (except when outside lever is locked by key from either side).</li> <li>• Outside lever remains locked upon egress</li> <li>• Inside lever always active.</li> </ul>  <p>Outside    Inside</p>
<p><b>4721LN (F80)</b></p> <p><b>Communicating Lock</b></p> <ul style="list-style-type: none"> <li>• For communicating or store entrance doors.</li> <li>• Deadlocking latchbolt.</li> <li>• Either lever operates latchbolt (except when key in either lever locks or unlocks the lever independently of the other).*</li> <li>• Should be used only in offices or rooms with multiple entries.</li> </ul> <p><b>(NOTE: Not available with I.C. core cylinders.)</b></p>  <p>Outside    Inside</p>	<p><b>4722LN (F90)</b></p> <p><b>Corridor Lock</b></p> <ul style="list-style-type: none"> <li>• Deadlocking latchbolt.</li> <li>• Either lever operates latchbolt (except when outside lever is locked by inside push-button or key in outside lever). Inside lever always active.</li> <li>• When locked by button, the button automatically releases when inside lever is turned or door is closed.</li> <li>• When locked by key, the automatic release is made inoperative and must be manually unlocked by key.</li> </ul>  <p>Outside    Inside</p>	<p><b>4725LN</b></p> <p><b>Privacy Lock</b></p> <ul style="list-style-type: none"> <li>• For lavatory or other privacy doors.</li> <li>• Either lever operates latchbolt (except when outside lever is locked by inside pushbutton).*</li> <li>• Button automatically releases by turning inside lever or closing door.</li> <li>• Door can be unlocked, when necessary, by operating outside turnbutton.</li> <li>• No emergency key required.</li> <li>• Optional flush turnbutton available for outside. Specify option "FTB".</li> </ul>  <p>Outside    Inside</p>	<p><b>4728LN (F111)</b></p> <p><b>Communicating Passage Lock</b></p> <ul style="list-style-type: none"> <li>• For twin communicating or exit doors where one side operation is required.</li> <li>• Also when space is limited between door and switch panel.</li> <li>• Deadlocking latchbolt.</li> <li>• One lever operation.</li> <li>• Blank rose.</li> <li>• Should be used only where rooms have more than one entrance.</li> </ul>  <p>Outside    Inside</p>
<p><b>4729LN (F113)</b></p> <p><b>Communicating Classroom Lock</b></p> <ul style="list-style-type: none"> <li>• For twin communicating or closet doors where one side operation is required or space between doors is limited.</li> <li>• Deadlocking latchbolt.</li> <li>• Inside lever operates latchbolt except when lever is locked by key.*</li> <li>• Blank rose.</li> <li>• Should be used only where rooms have more than one entrance.</li> </ul> <p><b>(NOTE: Not available with I.C. core cylinders)</b></p>  <p>Outside    Inside</p>		<p><b>4730LN</b></p> <p><b>Utility, Asylum or Institutional Lock</b></p> <ul style="list-style-type: none"> <li>• Deadlocking latchbolt.</li> <li>• Latchbolt operated by key in lever from either side.</li> <li>• Both levers always locked.*</li> </ul> <p><b>Note: Not available with IC core cylinders.</b></p>  <p>Outside    Inside</p>	

\* Lever handles are Free-Wheling in locked position. Shaded area denotes FreeWheling lever or rigid knob.

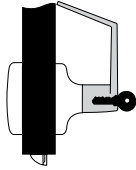
## functions

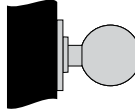
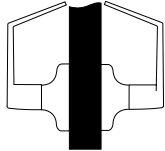
4739LN (F112)	4755LN	4755	4755LN-D
<p><b>Communicating Storeroom Lock</b></p> <ul style="list-style-type: none"> <li>• For twin communicating or closet doors where one side operation is required or space between doors is limited.</li> <li>• Deadlocking latchbolt.</li> <li>• Latchbolt operated by key only in inside lever.</li> <li>• Inside lever always locked.*</li> <li>• Blank rose.</li> <li>• Should be used only where rooms have more than one entrance.</li> </ul> <p><b>(Note: Not available with I.C. core cylinders)</b></p> <div data-bbox="240 869 375 1037">  </div> <div data-bbox="232 1052 386 1073"> <p>Outside    Inside</p> </div>	<p><b>Single Dummy Trim</b></p> <ul style="list-style-type: none"> <li>• For non-operational levers used for decorative trim.</li> <li>• Rigid lever.</li> </ul> <div data-bbox="599 888 683 1016">  </div> <div data-bbox="565 1052 719 1073"> <p>Outside    Inside</p> </div>	<div data-bbox="907 898 1040 1008">  </div> <div data-bbox="898 1052 1052 1073"> <p>Outside    Inside</p> </div>	<p><b>Double Dummy Trim</b></p> <ul style="list-style-type: none"> <li>• For non-operational lever used for decorative trim.</li> <li>• Through-bolted.</li> </ul> <div data-bbox="1227 877 1390 1026">  </div> <div data-bbox="1230 1052 1385 1073"> <p>Outside    Inside</p> </div>

\* Lever handles are Free-Wheeling in locked position. Shaded area denotes FreeWheeling lever or rigid knob.



## securex<sup>®</sup>

### operation

Electric locks provide the ability to electrically lock or unlock the outside trim from a remote location. Fail Safe locks are commonly used in stair towers to release upon fire alarm activation. Fail Secure locks are used on perimeter doors or security doors to allow ingress using access control technologies (proximity cards, keypads, etc.)



### features

- Free Wheeling lever mechanism.
- Self-contained, continuous-duty integral solenoid (allows installation in standard cylindrical prep).
- Available Fail Safe or Fail Secure.
- Available in 12 or 24 volts DC.
- External rectifier available upon request for AC operation.
- Mechanical cylinder override.
- All 4700LN cylinder options.
- Certified ANSI/BHMA Grade 1. 
- UL listed.
- 1-year limited warranty.

### electrical specifications

- Continuous duty solenoid  
150 mA @ 24VDC  
300 mA @ 12VDC

## electrolynx<sup>®</sup>

Yale<sup>®</sup> electrified 4700LN locks are equipped with *ElectroLynx* connectors. As a standard feature, these connectors link power from the incoming source to electrified locking products, including hinges, locks, exit devices, magnetic holders and strikes.

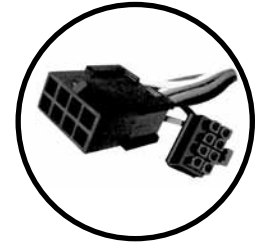

**Note: Electrified door hardware with *ElectroLynx* connectors requires a compatible number of lead wires attached to the door hinge.**

## functions

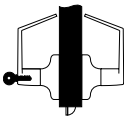
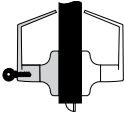
Outside	Inside	Function	Function Description
		4790LN	<b>Fail Safe</b> <ul style="list-style-type: none"> <li>• Power on locks outside lever.</li> <li>• Inside lever always active.</li> <li>• Latchbolt retracted by key when locked electrically.</li> <li>• Free Wheeling lever when locked electrically.</li> </ul>
		4791LN	<b>Fail Secure</b> <ul style="list-style-type: none"> <li>• Power on unlocks outside lever.</li> <li>• Inside lever always active.</li> <li>• Latchbolt retracted by key when power is off.</li> <li>• Free Wheeling lever when power is off (locked).</li> </ul>

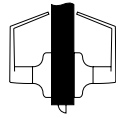
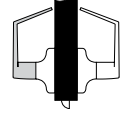
Outside	Inside	Function	Function Description
		4780LN	<b>Fail Safe</b> <ul style="list-style-type: none"> <li>• Power on locks outside lever.</li> <li>• Inside lever always active.</li> <li>• Latchbolt retracted either side except when outside lever is locked electrically.</li> <li>• Free Wheeling lever when locked electrically.</li> </ul>
		4781LN	<b>Fail Secure</b> <ul style="list-style-type: none"> <li>• Power on unlocks outside lever.</li> <li>• Inside lever always active.</li> <li>• Latchbolt retracted either side when power is off.</li> <li>• Free Wheeling lever when power is off (locked).</li> </ul>

## securex® accessories

BPS power supplies by securitron®

### Operation

Power supplies are designed to provide reliable filtered and regulated power for long life to a variety of electrified hardware components.

### Product Features

- Individual output circuit breakers
- Regulated and filtered fuse protected outputs
- LEDs monitor zone status (voltage or no voltage)
- Slide switches connect or disconnect load from power (Not available on 1 Amp supplies)
- Internal Back-Up battery charging circuit
- Rugged steel enclosure
- Fire alarm interface

### Listings

- UL CLASS 2

### Applications (use with):

- Fail Safe cylindrical locks
- Fail Secure cylindrical locks

### Ordering

Ex: BPS-24-4, BPS-12-3

Model	Input	Output	Application
BPS-24-1	120 VAC	1 Amp @ 24 VDC	2-4700LN
BPS-24-2	120 VAC	2 Amp @ 24 VDC	5-4700LN
BPS-24-4	120 VAC	4 Amp @ 24 VDC	11-4700LN
BPS-12-1	120 VAC	1 Amp @ 12 VDC	1-4700LN
BPS-12-3	120 VAC	2 Amp @ 12 VDC	3-4700LN

Consult factory for additional power supply applications.

Yale recommends McKinney®, Pemko and Securitron® for power transfer devices and other electronic accessories.

## cylinders

### cylinder options

The following selection guide indicates the correct cylinder for each locking segment.

Lockset Series: 4700(LN)		Types of Cylinder Mechanisms							
		Conventional		Protected Keyway		Security		High Security	
Cylinder Types	Fixed Core	6-pin	7-pin	6-pin	7-pin	6-pin	7-pin	6-pin	7-pin
	Key-In-Lever	1804	N/A	K402	N/A	5802	N/A	N/A	N/A
	Key-In-Knob	1805	N/A	N/A	N/A	N/A	N/A	N/A	N/A
	Interchangeable Core								
LFIC (Levers Only)	1210	N/A	K800	N/A	5210	N/A	N/A	N/A	N/A
SFIC	N/A	N/A	K600	K600	N/A	N/A	N/A	N/A	N/A

Refer to Yale® KeyMark® and/or Cylinders and Keys Catalog sections for all details and how-to-order examples.

**Note: The 1804 cylinder requires an adapter sleeve to fit in the 4700LN Lockset. (P/N 14-5305-9078-999)**

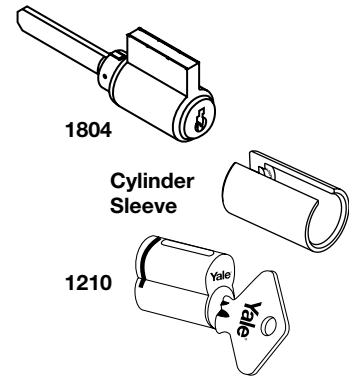

### Yale® KeyMark®

For those applications requiring protected key control, Yale® KeyMark® cylinders guard against unauthorized key duplication. The *Yale KeyMark Security Leg®* keyway feature increases resistance against picking and impressing and can easily retrofit into existing systems. For further details and availability, refer to the separate *Yale KeyMark* catalog.

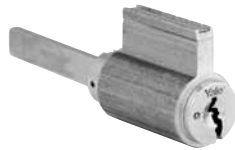

### security cylinders

Security cylinders contain two independent locking mechanisms. The first is a traditional 6-pin tumbler mechanism with spool drivers for greatly increased picking resistance.

The second is an innovative 5-tumbler rotating disc mechanism with sidebar engagement. The rotating discs are spring loaded and block the bottom of the keyway.

#### Illustration

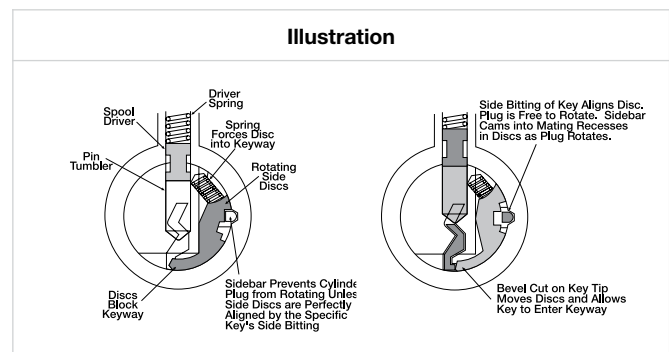

### 108S Schlage® cylinder adapter kit

Kit used to modify Schlage® cylinder for fit in the 4700LN.

P/N 14-5407-9101-999 - 108S

Kit includes tailpiece and sleeve. To order the 108S adapter kit, use an "S" prefix (i.e., S-AU4707LN).

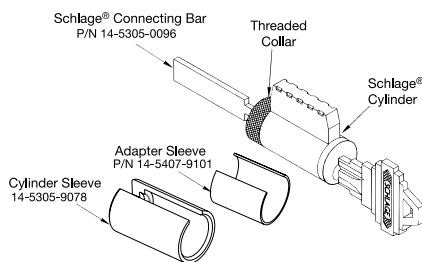

## cylinders/keying

## other manufacturer keyway cylinder/cores

Illustration	Type	Model Number		Number of Pins
		Lever	Knob	
	Best® Keyway Core. Available keyed random, master keyed or uncombined. Specify keyway A, B, C, D, E, F, G, H, J, K, L or M.	A600		6 or 7 (Specify)
 <b>Knob Cylinder</b>	Schlage® C Keyway Cylinder. Available 0-bitted or keyed random.	2804 x C	2805 x C	6
	Corbin Russwin L4 Keyway Cylinder. Available keyed random.	3804 x L4	3805 x L4	6
	Corbin 60 Keyway Cylinder. Available keyed random.	3804 x 60	3805 x 60	6
 <b>Lever Cylinder</b>	Russwin D1 Keyway Cylinder. Available keyed random.	3804 x D1	3805 x D1	6
	Sargent® LA Keyway Cylinder. Available keyed random.	3804 x LA	3805 x LA	6
	Schlage® E Keyway Cylinder. Available keyed random.	3804 x E	3805 x E	6

Notes: 2805, 3804 & 3805 cylinders are not ANSI/BHMA certified.

The 2804 and 3804 cylinders require an adapter sleeve (P/N 14-5407-9101-999) and a cylinder sleeve (P/N 14-5305-9078-999) to fit the 4700LN lockset.

## levers/knob accepting SFIC and other manufacturers' large format interchangeable cores

	Cylinder Type	Prefix	Number of Pins
	SFIC (Accepts all Small Format Interchangeable Cores)	B (i.e. B-AU, B-MO, B-PB)	6 or 7
	SFIC (Accepts all Small Format Interchangeable Cores)	B (i.e. B-CA)	6 or 7
	Medeco®, ASSA® (LFIC)	M* (i.e. M-AU)	6
	Schlage® (LFIC)	SI (i.e. SI-AU, SI-PB, SI-MO)	6

\*Medeco®, ASSA® option available only with AU lever. (Note: For Medeco 32 series cores.)

LFIC = Large Format Interchangeable Core

SFIC = Small Format Interchangeable Core

## latchbolts

### plain latchbolts

Model No. 693 supplied standard with all 4700(LN) series locksets without locking function. Standard plain latchbolt has a 2-1/4" (57mm) x 1-1/8" (29mm) beveled front with a 2-3/4" (70mm) backset and a 1/2" (13mm) bolt throw. Optional latchbolts with a greater backset/throw available to special order.

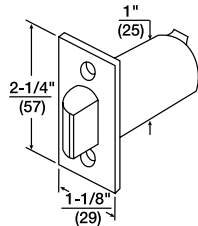

Series	Model No.	Front	Backset	Throw	Front Width	Latch Diameter
Lever (Std)	693	Beveled	2-3/4" (70mm)	1/2" (13mm)	1-1/8" (29mm)	1" (25mm)
Lever (Opt)	F693	Flat	2-3/4" (70mm)	1/2" (13mm)	1-1/8" (29mm)	1" (25mm)
Lever (Opt)	3693	Beveled	3-3/4" (95mm)	1/2" (13mm)	1-1/8" (29mm)	1" (25mm)
Knob (Std)	MCP134	Flat	2-3/4" (70mm)	1/2" (13mm)	1-1/8" (29mm)	1" (25mm)

**Note: for 3/4" throw applications, only deadlocking latchbolts available.**

### deadlocking latchbolts

Deadlocking latchbolt Model No. 694 supplied standard with all 4700(LN) series locksets with locking function. Standard deadlocking latchbolt has a 2-1/4" (57mm) x 1-1/8" (29mm) beveled front with a 2-3/4" (70mm) backset and a 1/2" (13mm) bolt throw. Optional latchbolts with a greater backset/throw available to special order.

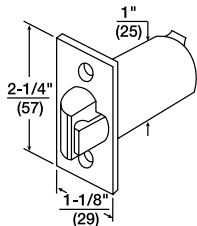

Series	Model No.	Front	Backset	Throw	Front Width	Latch Diameter
Lever (Std)	694	Beveled	2-3/4" (70mm)	1/2" (13mm)	1-1/8" (29mm)	1" (25mm)
Lever (Opt)	F694	Flat	2-3/4" (70mm)	1/2" (13mm)	1-1/8" (29mm)	1" (25mm)
Lever (Opt)	3694	Beveled	3-3/4" (95mm)	1/2" (13mm)	1-1/8" (29mm)	1" (25mm)
Lever (Opt)	480B	Beveled	2-3/4" (70mm)	3/4" (19mm)	1-1/8" (29mm)	1" (25mm)
Lever (Opt)	F480B	Flat	2-3/4" (70mm)	3/4" (19mm)	1-1/8" (29mm)	1" (25mm)
Lever (Opt)	3480B	Beveled	3-3/4" (95mm)	3/4" (19mm)	1-1/8" (29mm)	1" (25mm)
Knob (Std)	MCD134	Flat	2-3/4" (70mm)	1/2" (13mm)	1-1/8" (29mm)	1" (25mm)

**Note: For 2-3/8" backset, contact Customer Support.**

### backset extension links

All 4700LN Series locksets are supplied with standard latchbolts of 2-3/4" (70mm) backset; optional latchbolts with a 3-3/4" (95mm) backset are available to special order. Extension links are also available for attachment to 2-3/4" (70mm) or 3-3/4" (95mm) backset latchbolts to extend the backset to the desired length.

Desired Backset	Latchbolt Backset	Order Extension List No.
5" (127mm)	2-3/4" (70mm)	481DL
6" (152mm)	3-3/4" (95mm)	481
7" (178mm)	2-3/4" (70mm)	482
8" (203mm)	3-3/4" (95mm)	482
18" (46cm)	2-3/4" (70mm)	484
19" (48cm)	3-3/4" (95mm)	484

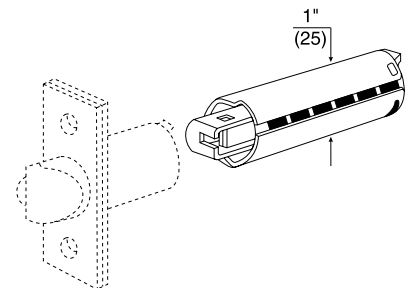

**Other extension links up to 42" (1.06m) backset are available to special order.**

### attaching screws

(Not regularly supplied when latchbolts ordered separately).

- For all latchbolts**

#8-8-32 x 3/4" (19mm) Phillips flat head combination wood and machine screws  
 Brass - P/N 81-2022-0416\*  
 Bronze - P/N 81-2032-0416\*

- Hollow Metal Doors**

#8 - 32 x 1" (25mm) Phillips flat head machine screw  
 Brass - P/N 81-0022-0420\*  
 Bronze - P/N 81-0032-0420\*

## strikes

Yale® 4700(LN) locks are available with a variety of strike options. All strikes are located on the same vertical and horizontal center lines as the latchbolt. Some strikes are available in a variety of lip lengths to accommodate varying thickness of doors and frames. To determine the proper length of the lip, measure from the center line of the strike to the edge of the jamb, accounting for any interfering trim (i.e. wood molding) and then add 1/4" (6mm) for curved lip. All strikes are reversible. Strikes are fabricated of either brass, bronze or stainless steel, depending on the lockset trim finish. When ordering strikes separately, specify the finish required.

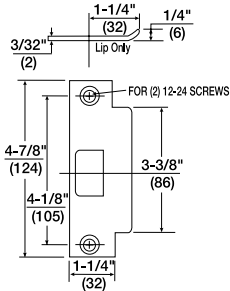
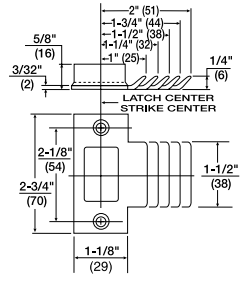
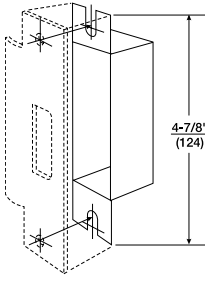
 <p><b>Model No. 497 ANSI Strike (Standard)</b> For door and frames with ANSI/BHMA A156.115 preparations. 4-7/8" x 1-1/4" x 1-1/4" (124mm x 32mm x 32mm) lip to center supplied standard. Optional lip lengths are not available. Available with optional 202 Strike Box. Specify 497 x 202.</p>	 <p><b>Model No. 371 T-Strike (Optional Lever Only)</b> 2-3/4" x 1-1/8" x 1-1/4" (70mm x 29mm x 32mm) lip to center available as an option. 1", 1-1/2", 1-3/4" and 2" curved lip lengths available by special order. Wrought strike box supplied.</p>	 <p><b>Model No. 202 Strike Box (Optional)</b> Available to special order. Specify 497 x 202.</p>
---	--	--

## attaching screws

(Not regularly supplied when strikes ordered separately).

### For Model No. 497

#12-24 x 1" Phillips flat head combination wood and machine screws.

P/N 81-2012-0620

### For Model No. 371

#8-32 x 3/4" (19mm) Phillips flat head combination wood and machine screws.

P/N 81-2012-0416



## how to order

Design	Function	Hand	Latch	Strike	Cylinder	Door Thickness	Finish
See page 3	See pages 4-6	See page 2	See page 11	See page 12	See pages 9-10	See page 2	See page 2

## ordering examples

Lever							
Design	Function	Hand	Latch	Strike	Cylinder	Door Thickness	Finish
AU	4707LN	RH	694	497	1804	1-3/4"	626

Knob							
Design	Function	Hand	Latch	Strike	Cylinder	Door Thickness	Finish
CA	4707	RH	MCD134	497	1805	1-3/4"	630

## online literature and templates

---

For the latest information on Yale Locks & Hardware products, visit our website at: [www.yalelocks.com](http://www.yalelocks.com)

Click on the “Product Information” button to find:

- Catalogs
- Parts manuals
- Templates
- Specifications
- Installation instructions

Yale® customers can click on the ebusiness symbol  on the website to register for an ebusiness account to:

- Check the status of orders
- Check availability of Quick-Ship items
- Track your order and confirm delivery
- Receive email notification of template changes
- And More...

Or contact us at:

### U.S.A.

#### Yale Locks & Hardware

Address: 100 Yale Avenue, Lenoir City, TN 37771-3226  
Tel: 1-800-438-1951 • Fax: 1-800-338-0965 • [www.yalelocks.com](http://www.yalelocks.com)

### Canada:

#### ASSA ABLOY Door Security Solutions Canada

Address: 160 Four Valley Drive, Vaughan, Ontario L4K 4T9  
Tel: 1-800-461-3007 • Fax: 1-800-461-8989 • [www.assaabloy.ca](http://www.assaabloy.ca)

### International:

#### ASSA ABLOY Americas International

Tel: 1-905-821-7775 • Fax: 1-905-821-1429 • [www.assaabloyai.com](http://www.assaabloyai.com)

Yale Locks & Hardware is a division of Yale Security Inc., an ASSA ABLOY Group company.

Yale® and SecureX® are registered trademarks of Yale Security Inc., an ASSA ABLOY Group company. Other products' brand names may be trademarks or registered trademarks of their respective owners and are mentioned for reference purposes only. These materials are protected under U.S. copyright laws. All contents current at time of publication. Yale Security Inc. reserves the right to change availability of any item in this catalog, its design, construction, and/or its materials. Copyright © 2010, 2012 Yale Security Inc., an ASSA ABLOY Group company. All rights reserved. Reproduction in whole or in part without the express written permission of the Yale Security Inc., an ASSA ABLOY Group company, is prohibited.

**YALE**, with its unique global reach and range of products, is the world's favorite lock.

**ASSA ABLOY** is the global leader in door opening solutions, dedicated to satisfying end-user needs for security, safety and convenience.

42702-2/12R