

Key Systems

Cylinders and Keys



ASSA ABLOY, the global leader
in door opening solutions

Applications

Key Systems

Table of Contents

- Designing Master Key Systems 3
- Key Wizard® 4
- How to Order Cylinders 5
- Cylinder and Key Stamping 6
- Temporary Access 7
- Conventional Cylinders 8
- Interchangeable Core 14
- Security 17
- Master Ring 19
- Pyramid 21
- Bump Resistant Cylinders 28
- Key Blanks 29
- Keyways 31
- Mortise Cylinder Cams 40
- Cylinder Accessories 41
- Plug Diameters/Quick Codes .. 43
- Service Equipment 45
- Policies and Procedures 49
- How to Establish Key Systems 50

www.corbinrusswin.com

Applications

To provide the desired level of security, even the finest architectural hardware requires a properly designed and maintained master key system.

The keying system is the "software" of a building's security. As shown in the schematic below, it turns each hardware product into an access control device.

The choice of cylinder mechanism must be planned together with the keying system. The variety of mechanisms available from Corbin Russwin offers the right balance of security, convenience and expansion capability for every job.

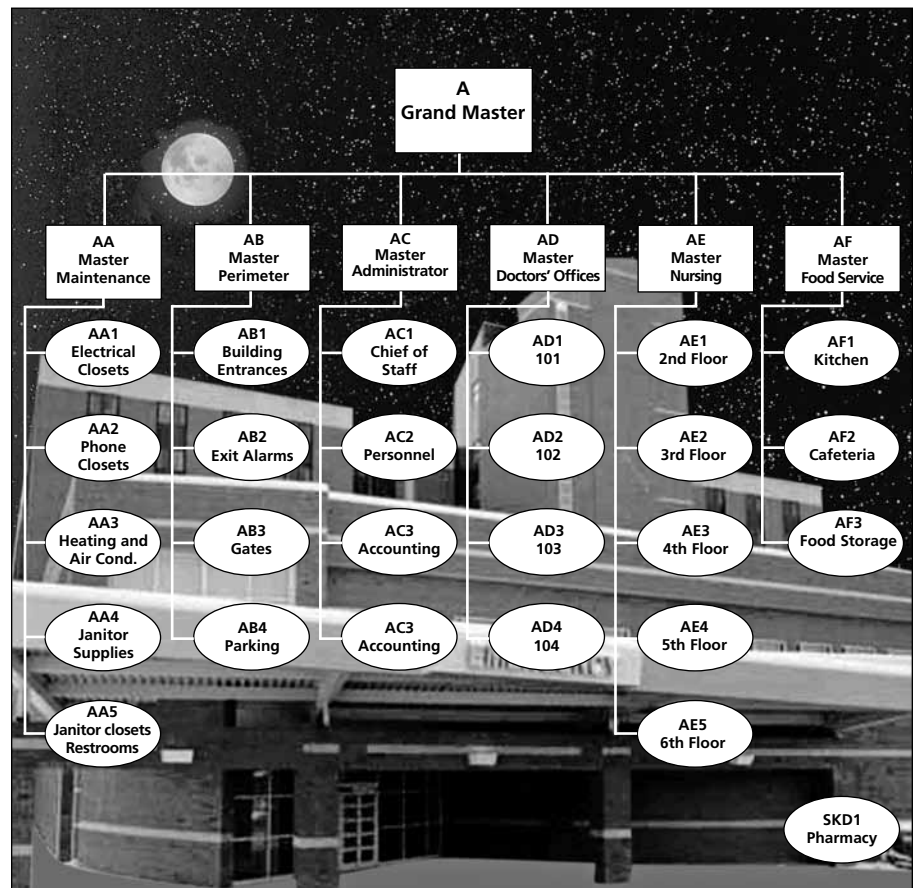

Key Systems

Step 1

Determine the type of locking system

- Conventional "open & restricted keyways"
 - Not contract controlled
- Patented locking system
 - A notice of acceptance will be required between Corbin Russwin and Owner
 - Factory-based system
 - Key blank distribution restrictions are in place
- Security (secondary locking mechanisms, example; Pyramid Security)
- High security (same as Security plus UL437 – example; Pyramid High Security)
- Standalone access control locking devices (at door wiring, example; Access 800)
 - To facilitate multiple users through common doors
- Integrated locking systems (hard wired into access control systems)

Step 2

Establish the level of the master key system. The higher the level the less secure.

- Level two – "Simple Master Key system"
 - Change key, and master key only
- Level three – "Grand Master Key system"
 - Change key, master key, and Grand Master Key
- Level four – "Great Grand Master Key system"
 - Change key, master key, Grand Master Key, and Great Grand Master Key
- Levels higher than four are not recommended for security reasons
 - With more levels, additional master pins in each chamber of the cylinder would be required, and with the additional master pins the possibility of unauthorized key interchanges could occur

See pages 50-52 on How to Establish Key Systems.

Step 3

Establish key hierarchy, key issuing policies and procedures, and administrative disciplines.

- Who, if anyone is authorized to carry the top master key?
- Who carries master keys and change keys?
 - Does every employee receive a key?

- What disciplinary action(s) is being put in place for violations?
 - Fines or Deposits
 - > Lost keys
 - > Keys not returned
 - Will there be a key receipt required?
 - > Where will that be kept?
- Who is the systems administrator?
 - Authorized to purchase
 - Responsible for Key Control Administration
- Who is the Key Control Administrator?
 - Maintain key control software & all transactions

Step 4

System Layout

- Helpful Hints
 - KISS "Keep It Simple System"
 - > Do not use the term sub-master (not unless it's level 6 and higher)
- Lowest level possible
- Key to the building security objectives NOT to the people
 - Determine if the system is to be designed for Security or Convenience
- No cross keying, especially with patented locking systems and higher
- Key alike within master key groups as much as possible
 - Avoid top-heavy systems (example; few change keys used under masters)
- Has the right function of lockset been selected?
 - Storeroom vs. Classroom vs. Entry
 - Single cylinder vs. double cylinder
 - > If double cylinder, how is the inside cylinder to be keyed?
- Provide adequate quantity of keys
 - Top Master keys "limit the number of these to only a few"
 - Master keys "also limit the number these"
 - Change keys per key set and/or per keyed alike sets
 - Special operating keys
 - > Control keys "limit the number of these"

Separate the internal departments into sectors, example are:

- Perimeter
 - Including all exterior doors, roof surfaces, gates and fences, and adjacent buildings.
- Operations
 - Sensitive areas crucial to daily operations, such as plant engineering, security and mechanical operations.

- Management
 - Areas that are vital for daily business activities, primarily human resources, administration, executive offices, IT, sales, and accounting.
- Services
 - Areas that provide employees and visitors with services, such as restrooms, medical treatment areas, housekeeping, food service, retail (unless it's a leased outside source).
- Unique Applications
 - Door openings requiring access control hardware where key override is required, or any other special application which would be unique.
- Tenants
 - Any tenants that are not part of the building.

Step 5

Servicing & Maintenance

- In-house or outside locksmith
 - Ensure proper training
 - Establish key cutting log
 - Establish service request procedures
- Service equipment
 - Key kit
 - Code cutter that complies with systems depths & spacing specifications
 - Locksmithing tools, fixtures & accessories
- Establish stock levels & requirements to avoid misuse of multi-section key blanks
 - Additional cylinders ready for emergencies
 - Additional key blanks (of all keyways)
- Who or where are the key blanks going to be kept?
- Who is authorized to cut keys?
 - What form of work order will be used to authorize cutting of keys?
 - Who will sign the work order?
 - What records will be kept & where?
- What type of reports will be required?
 - Overdue keys
 - Miss-cut keys
 - > Who receives the reports?
- Once a key has been cut, what instructions are given to the recipient?
 - Key receipt recommended
- Ensure that all transactions are recorded by the Key Control Administrator
- ENFORCEMENT FROM THE START! SUPPORT AND BACK THOSE WHO ARE RESPONSIBLE FOR MAINTAINING AND SERVICING THE SYSTEM.

Key Wizard®

Key Systems

Key Management Software

Advantages

A key management software program is essential for any type of organization. Keeping track of the key holders in a master key system is critical for maintaining key control and ensuring the security and integrity of the system. *Key Wizard* by Corbin Russwin was designed to provide a user-friendly tool for facility end users to track detailed information concerning their keying system. It offers improvements over existing key management software by utilizing clutter-free and easily navigated screens. This system uses a Microsoft®

Outlook® type of layout.

Key control for a facility is maintained by adopting a complete system of policies, procedures, record keeping and specialized products. A comprehensive key management software program is one aspect of a complete key control system.

Key Wizard by Corbin Russwin provides the facility with accurate information concerning keys, key holders, hardware locations, master key systems, overdue keys and maintenance service schedules, all of which can be customized.



Features:

- Free technical support and free software upgrades for one year
- Customized query, report and search capability
- Comprehensive hardware listings for door locations
- Displays key holder photos and signatures for verification
- Clear, easy to read screens
- Automatic reminders for maintenance, back-ups and overdue keys
- Network and standalone versions available
- Accurate key symbol sorting
- Audit trail tracks changes made to keyholders
- Printing of door number labels to ensure proper cylinder installation
- Key authorization tracking

- Customized key receipts and authorization forms
- Tracking of loaned keys and key deposits
- Stores maintenance service history records
- Can manage multiple end users and multiple key systems for most manufacturers
- Importing of key systems, keyholders and locations
- Exporting of key systems and locations
- Global key search across multiple master key systems
- Multi-level password protection
- Download of key bittings to ITL9700 Code machine
- Pinning Calculators

Computer System Requirements:

- 500 MHz processor or greater
- Windows 98, 2000, ME, NT, XP, Vista or 7
- 64 MB RAM
- CD Drive
- Mouse pointing device
- 70 MB hard disk space

How to Order:

All *Key Wizard* programs are licensed specifically to each facility end user. Special online ordering procedures apply. The following information is required for each system:

End User Facility Name
End User Contact Individual
Mailing Address
Phone Number

Demo Version

Demo versions are available. Demos can be downloaded from the Corbin Russwin website at <http://www.corbinrusswin.com> or www.keywizard.net

Key Wizard Technical Support:

1-800-610-1706

How to Order Cylinders

Numbering Scheme Overview

Key Systems

Cylinder Type	Mechanism	Function	Length	Cam	Pins	Keyway
10 Mortise	0 Standard	0 Standard	(Mortise Cylinder)	A01 Cloverleaf	5	
11 Flex Head Mortise	1 Security	1 Hotel	100 1" (25mm)	A02 Straight	6	
12 Concealed Shell Mortise	2 Pyramid	2 Blockout	118 1-1/8" (29 mm)	A03 Adams Rite® MS	7	
13 Thumbturn Mortise	3 IC Pyramid	3 Classroom	114 1-1/4" (32 mm)	A04 DL4000 Series		
14 Dummy Mortise	Cylinder (LFIC)	4 Brink CW	138 1-3/8" (35 mm)	A05 Adams Rite 4070		
20 Knob/Lever	4 SFIC Housing	5 Brink CCW	112 1-1/2" (38 mm)	A06 Schlage® Cloverleaf		
21 Continental Knob	6 Master Ring	6 Obsolete Crossbar	134 1-3/4" (44mm)	A07 DL4100 Series		
22 Competitor Knob/Lever	7 LFIC Housing	ED6200	200 2" (51 mm)	A61 New MR Cloverleaf-locks made after 5/93		
24 Competitor Keyways	8 IC Complete	7 Pyramid Security	214 2-1/4" (57 mm)	A62 MR Straight		
30 Rim	Cylinder (LFIC)		212 2-1/2" (64 mm)	A63 Large MR Short		
33 Thumbturn Rim	9 IC Security		234 2-3/4" (70 mm)	A64 Large MR Long		
42 Special Application	Cylinder (LFIC)		300 3" (76 mm)	A65 Old MR Cloverleaf - locks made prior to 5/93		
43 DL2100, DL3100			314 3-1/4" (83 mm)	A92 Exit Grip Trim 01, 02		
80 IC-Core Only (LFIC)			312 3-1/2" (89 mm)	A93 Obsolete Deadlocks: Corbin® 610 Series and Russwin® 1403 Series		
			334 3-3/4" (95 mm)			
			(Rim Tailpiece)			
			058 5/8" (16 mm)			
			114 1-1/4" (32 mm) IC			
			138 1-3/8" (35 mm)			
			178 1-7/8" (48 mm) IC			
			178V 1-7/8" (48 mm) vertical IC			
			200 2" (51 mm)			
			200V 2" (51 mm) vertical			
			318 3-1/8" (78 mm) IC			
			312 3-1/2" (89 mm)			
			312V 3-1/2" (89 mm) vertical			

Finish	
Description	Specify
Bright Brass	605
Satin Brass	606
Bright Bronze	611
Satin Bronze	612
Dark Oxidized Satin Bronze, Oil rubbed	613
Bright Nickel Plated	618
Satin Nickel Plated	619
Flat Black Coated	622
Bright Chromium Plated	625
Satin Chromium Plated	626
Bright Stainless Steel	629
Satin Stainless Steel	630
Black Oxidized Bronze, oil rubbed	722

Key Systems

Visual and Concealed Key Control

With these options, keys and/or cylinders are stamped with their respective keyset symbol, so lock mix-ups during installation or key mix-ups afterwards are less likely to happen – and easier to straighten out if they do. Lost keys are also easier to replace. The coded information on the cylinder tells you how the cylinder is keyed, thereby eliminating trial and error.

For example, the symbol AA1 shown in the illustration identifies the lock to be operated by grand master key A, master key AA and change key AA1. Upon written authorization from the building owner to an authorized Corbin Russwin Distributor, a bitting list can be furnished for each job to translate the symbols into key bittings.

If a key is lost, it can easily be replaced by referring to the symbol on the cylinder and the bitting on the bitting list. VKC is not available on Security or Pyramid cylinders.

Visual Key Control (VKC) For Greater Convenience

The key symbol is stamped on the plug face or other visible portion of the front of the cylinder. (VKC is available on all keys, but not available on Security, CK4400 Series Lockset or Pyramid cylinders.)

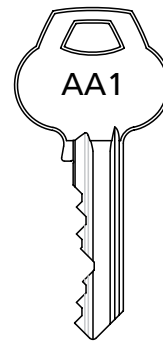
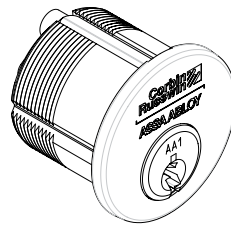

Concealed Key Control (CKC) For Greater Security

For greater security, specify CKC on the cylinders. The key symbol is stamped in a concealed location, such as the rear of the cylinder. It is not visible to the general occupants of the building but can be accessed by authorized personnel upon removing the cylinder from the lockset.

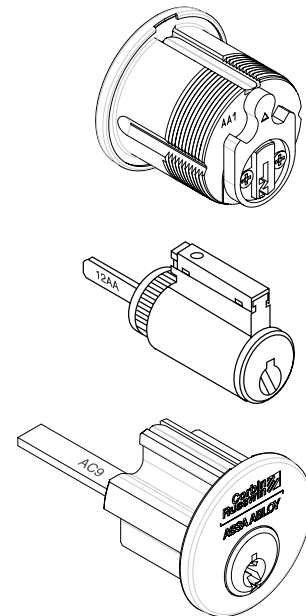

The following codes and definitions have been established for specifying cylinder and key stamping:

Quick Code	Definition
VKC0	No keyset, registry number, keyway, nor bitting stamping on any keys. Includes master keys and change keys. (Keys will be tagged.)
VKC1	Master keys stamped with their keyset symbol and registry number. Change keys stamped with their keyset symbol and keyway.* (Standard for high security and security cylinders.)
VKC2	Master Keys stamped with their keyset symbol and registry number. Change keys stamped with their keyset symbol and keyway.* Cylinders stamped with their keyset symbol on the face of the plug. (Not available for high security or security cylinders.)
VKC3	Master Keys stamped with their registry number. Change keys stamped with their bitting, keyway* and system. Cylinders stamped with their keyset symbol on the face of the plug. (Not available for high security or security cylinders.)
CKC2	Master keys stamped with their keyset symbol and registry number. Change keys stamped with their keyset symbol and keyway.* Cylinders stamped with their keyset symbol in a concealed location.
CKC3	Master keys stamped with their registry number. Change keys stamped with their bitting, keyway* and system. Cylinders stamped with their keyset symbol in a concealed location. (Not available for high security, or security cylinders.)

*Keyway will NOT be stamped on the keys for security or high security cylinders, nor restricted or patented keyways unless specifically requested as per the purchase order. (KB18, KB19, KB28 or KB90 series)



Construction Master Keying

Construction Master Keying (CMK) is a Corbin Russwin keying option that provides the extra security needed in the transition from construction of a building or complex to completion.

The construction master key operates all Corbin Russwin cylinders while the building is under construction. Upon completion of the construction phase, it can be voided without removing the cylinders from the locks, simply by turning the change key in each cylinder. Interchangeable core jobs with construction master keying further require a construction control key to install and remove cores during the construction phase.

The permanent master and change keys for the system are always packed and shipped separately, and the order must include the names and addresses of individuals to whom the construction, permanent master and change keys should be sent.

This feature is NOT available on Security or Pyramid cylinders.

SKD Caution

Unless otherwise specified, SKD sets will be construction master keyed. When construction master keying is established for SKD sets, Corbin Russwin issues a separate SKD CMK key as well as an SKD CMK Control key if required.

How to Order CMK

To order locksets and/or cylinders with the construction master key feature, the quick code CMK should be indicated as an option.

Temporary Construction Cores

Lockable

A more secure method of construction keying for interchangeable core hardware is the use of temporary construction cores. Corbin Russwin recommends this method of construction keying for IC jobs.

Hardware is furnished with construction cores that are keyed alike to a combination unrelated to the permanent system's master key. When the building is turned over to the owner, the permanent cores are installed and the temporary construction cores can be returned to Corbin Russwin for credit.

The IC temporary construction cores are available in red, blue and green. The color options enhance the user's ability to easily control access to different locations on a construction site, or identify different locations for specific keying applications.

How to Order Lockable

For 6-pin, use quick code CT6
 IC 6-pin with Red temporary construction core (Red), CT6R
 IC 6-pin with temporary construction core (Blue), CT6B
 IC 6-pin with temporary construction core (Green), CT6G
 For 7-pin, use quick code, CT7
 IC 7-pin with temporary construction core (Red), CT7R
 IC 7-pin with temporary construction core (Blue), CT7B
 IC 7-pin with temporary construction core (Green), CT7G
 For Pyramid, use quick code CTP.

Note: Orders specifying only CT6 or CT7 without the color designation will receive the Red IC temporary construction core by default.

Examples:

ML2051 x LSA x 626 x RH x CT6
 1080 x 114 x A01 x 626 x CTP
 CL3355 x NZD x 626 x CT6B
 1080-114-A01 x 626 x CT6G
 Permanent cores must be ordered separately.

Disposable

Corbin Russwin offers two formats of disposable temporary cores. These cores do not require keys for their operation and no returns or credits are allowed.

Disposable cores are available for Corbin Russwin large format interchangeable core (LFIC) housings or for small format interchangeable core (SFIC) housings. **Please note that Corbin Russwin does not provide permanently keyed SFIC cores.**

How to Order Disposable

LFIC
 For 6-pin, use quick code CT6D
 For 7-pin, use quick code CT7D
 For Pyramid, use quick code CTPD

Examples:

ML2051 x LSA x 626 x RH x CT6D
 1080 x 114 x A01 x 626 x CTPD
 Permanent cores must be ordered separately.

SFIC - Key-in-lever/knob locksets
 For 6- and 7-pin, use quick code CTSD

SFIC - Mortise Locks and Exit Devices-Rim Cylinders
 For 6-pin housing, use quick code CLS6
 For 7-pin housing, use quick code CLS7

Mortise Cylinders

For use with all mortise locks and DL3000 Deadlocks. IC: page 15. Security: page 17. Master Ring: page 20. Pyramid: page 24.



Type	Length	Cam	Pins	Keyway	Finish
1000	100 1" (5 pin only)	(see page 40)	5	(see pages 31-39)	605
	118 1-1/8" (standard)	A01 Cloverleaf	6 (standard)		606
	114 1-1/4"	A02 Straight	7 (available for 1-1/4"-3")		611
	138 1-3/8"	A03 Adams Rite® MS and			612
	112 1-1/2"	DL3000 Deadlock			613
	134 1-3/4"	A04 DL4000 Deadlock			622
	200 2"	A05 Adams Rite 4070			625
	214 2-1/4"	A06 Schlage® Cloverleaf			626
	212 1-1/2"	A07 DL4100			629
	234 2-3/4"	A92 Exit Grip Trim 01 & 02			630
	300 3"	A93 Obsolete deadlocks:			722
	314 3-1/4"	Corbin® 610 Series and Russwin® 1403 Series			
	312 3-1/2"				
	334 3-3/4"				

Flexible Head Mortise Cylinders

Use Flexible Head mortise cylinders only with sectional trim mortise locks. The head is spring-loaded to adjust for minor variations in door thickness. See page 20 for Master Ring.



Type	Length	Cam	Pins	Keyway	Finish
1100	100 1" (6-pin std.)	(see page 40)	6 (standard)	(see pages 31-39)	605
	118 1-1/8"	A01 Cloverleaf	7 (available only for 1-1/8" - 1-1/4")		606
	114 1-1/4"	A02 Straight			611
					612
					613
					618
					619
					625
					626
					722

Concealed Shell Mortise Cylinders

Concealed shell cylinders are for mortise locks using "Plug Only to Show" escutcheon trim.



Type	Length	Cam	Pins	Keyway	Finish
1200	100 1" (6-pin std.)	(see page 40)	6 (standard)	(see pages 31-39)	606
	118 1-1/8"	A01 Cloverleaf	7 (available only for 1-1/4" - 1-1/2")		626
	114 1-1/4"	A02 Straight			
	138 1-3/8"				
	112 1-1/2"				

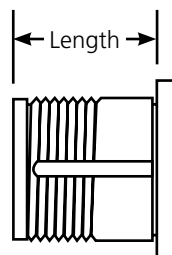

Length is measured from behind the cylinder head to the end of the cam.
For cam illustrations and applications, see page 40.

Conventional Key Systems

Mortise

Hotel Function Cylinders

Guest Key and all normal master keys have limited rotation to retract latchbolt only. Emergency Master Key (EMK) and display key turn 360° to operate deadbolt as well.

Brink Function Cylinders

The change key turns in only one direction while the master key turns in both directions. While it was developed for the detention market, the cylinder can provide a creative solution to other security needs when used in conventional mortise locks. 6-pin only. Integration of these cylinders must be planned from the inception of a keying system.

Cylinder for Obsolete Exit Device

For inside of obsolete Corbin® 3726 1/2 and 3727 1/2 and Russwin® 736 1/2 and 737 1/2 only. Cam rotation is limited by steel pins on back of shell.

Type	Number	Remarks
Standard	1001-114-A01	Cylinders are 6-pin. Display and Emergency Master Keys are cut on 7-pin blanks
Flexible Head	1101-118-A01	
Concealed Shell	1201-114-A01	

Not available with D1, D2, L1, L2, 752, 852 or A Class keyways. Order with A91 cam to accept discontinued Russwin® "G" type long EMK.

Finishes: see Standard, Flexible Head and Concealed Shell Cylinder sections, page 8.

Application	Number	Remarks
Folger Adam® NS400 Series x LEK	1004-118-A02	Clockwise
Folger Adam NS400 Series x LEK	1005-118-A02	Counterclockwise
Brink "CKS"	1004-118-A05	Clockwise
Brink "CKS"	1005-118-A05	Counterclockwise

Finishes: 605, 606, 611, 612, 613, 625, 626, 629, 630, 722

1006-118-A02 (6-pin only)
Finishes: 605, 606, 611, 612, 613, 622, 625, 626, 629, 630, 722

Thumbturn Cylinders



Classroom function cylinders have a pin to block cam rotation in the locking direction. The pin may be installed on either side of the cam, depending on the hand of the door.

Suffix cam number to basic cylinder number. Example: 1300-118-A03					
Function	Length	Basic Number	A02 (147F77)	A03 (111F55)	A93 (281F27)
Standard	1"	1300-100-	•	•	N/A
	1-1/8"	1300-118-	•	•	•
	1-1/4"	1300-114-	•	•	N/A
	1-3/8"	1300-138-	•	•	N/A
Classroom	1"	1303-100-	N/A	•	N/A
	1-1/8"	1303-118-	N/A	•	N/A
	1-1/4"	1303-114-	N/A	•	N/A
	1-3/8"	1303-138-	N/A	•	N/A

Finishes: 605, 606, 611, 612, 613, 622, 625, 626, 629, 630, 722

Dummy Cylinders



These cylinders may be used to fill an opening left when mortise cylinder operation is no longer desired.

Number	Length
1400-118	1-1/8"
1400-114	1-1/4"
1400-138	1-3/8"

Finishes: 605, 606, 611, 612, 613, 622, 625, 626, 629, 630

Conventional Key Systems

Component (Key-in-Lever/Knob)

Component Cylinders Finishes 606, 626

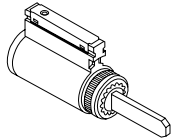

2000-033, 034 or 037

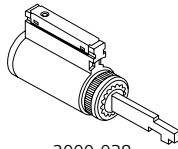

2000-038

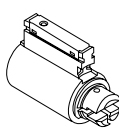

2000-052

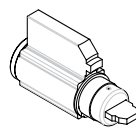

2000-044

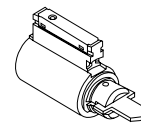

2000-051

Type	Tailpiece	Series	Lever (Plug diameter)	Knob (Plug diameter)	Tailpiece Part Number (Length) 6-Pin	Tailpiece Part Number (Length) 7-Pin	
2000	033	CL3300, CL3500, CL3800, CL3600 (June 2000 and after) Lever Trim - A6/N6/PR6	(.509")		622F308 (.950")	682F298 (.794")	
	033H	G1055 ED Trim (Horizontal Tailpiece)		(.509")	622F308 (.950")	682F298 (.794")	
	034	CL3400 (Lockset Series Obsolete) CL3600 (Prior to June 2000), A5/N5	(.509")		622F298 (1.106")	622F308 (.950")	
	037	CL3700 CK4700	(.509")	(.509")	682F298 (.794")	NA	
	038	CL3800 (Obsolete 1993-1997 model)	(.509")		596F898 (1.056")	NA	
	039	CL3900	(.509")		680F608 (1.700")	NA	
	039L	CL3900 (2", 2-1/4" Thick Doors)	(.509")		681F068 (1.950")	NA	
	044	CK4400		(.509")	NA Separately	NA	
	051	B2/G2/G3 ED Trim			(.552")	489F028 (.890")	NA
	052	UT5200/CK4200		(.552")	(.552")	No Tailpiece	NA

Note #1= For 7-pin version, suffix -7 i.e. 2000-033-7

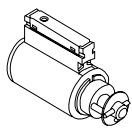

2001-052

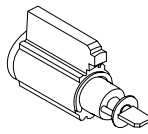

2001-044

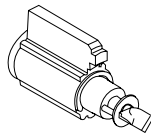

2001-066

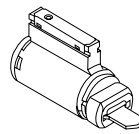

2001-051

Type	Tailpiece	Series	Lever (Plug diameter)	Knob (Plug diameter)	Tailpiece Part Number (Length) 6-Pin	Tailpiece Part Number (Length) 7-Pin	Remarks
2001	034	CL3329/CL3629 CL3429 (Lockset Series Obsolete)	(.509")		585F338 (1.046")	585F358 (.890")	Use 2001-034-E8 for EMK Blank
	044	CK4429 (Straight Tailpiece)		(.509")	564F508 (.764")	NA	Use 2001-044-E4 for EMK Blank
	051	Model 83 Only B2/G2/G3 ED Trim 1400/3300/4300/5600 (Lockset Series Obsolete)		(.552")	186F748 (.965")	NA	Use 2001-051-E5 for EMK Blank
	052	CK4229	(.552")	(.552")	No Tailpiece	NA	Use 2001-052-E4 for EMK Blank
	066	CK4429 (Twisted Tailpiece)		(.509")	574F128 (.835")	NA	Use 2001-066-E4 for EMK Blank

Note #1= For 7-pin version, suffix -7, i.e. 2000-033-7

Note #2= 2003-044 used for CK4455 & CK4482 prior to August 1993

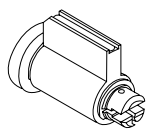

2100-052

Type	Tailpiece	Series	Lever (Plug diameter)	Knob (Plug diameter)	Tailpiece Part Number (Length) 6-Pin	Tailpiece Part Number (Length) 7-Pin	Remarks
2100	052	Ronde and Continental Knob (Obsolete)		(.552")	No Tailpiece	NA	Finishes 605, 606, 611, 612, 613, 625, 626

Conventional Key Systems

Component (Key-in-Lever/Knob)

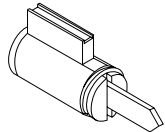

2200-001

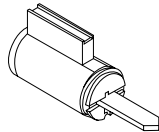

2200-002

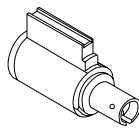

2200-008

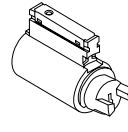

2200-076

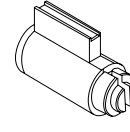

2200-054

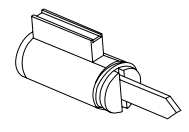

2200-003

Cylinders for Other Manufacturer's Products

Type	Tailpiece	Series	Lever (Plug diameter)	Knob (Plug diameter)	Tailpiece Part Number (Length)	Tailpiece Orientation
2200	001-A21	Alarm Lock DL2500 Series	(.552")	(.552")	444F748 (.813")	Vertical
		Arrow® H Series Knobs and Levers				
		Arrow Q Series Levers				
		Sargent® 10 Line (Enlarge Lever Hole)				
		Schlage® D Series Levers				
	001-A22	Schlage AL and ND Series Levers	(.552")		461F108 (1.078")	Vertical
	002-A21	Schlage D Series Knobs		(.552")	444F748 (.813")	Horizontal
	002-A22	Schlage A Series Knobs (PLY, etc.)		(.552")	461F108 (1.078")	Horizontal
	002-A23	Schlage A Series Knobs (ORB, only)		(.552")	520F358 (1.328")	Horizontal
	003-A24	Lockwood® H Series Knobs (Enlarge Knob Hole)		(.552")	444F748 (.813")	Vertical
008	Sargent 7,8,9 Line (Enlarge Knob Hole)		(.552")	NA		
054	Yale® 5400, 6200 Knobs Only (Enlarge Knob Hole)		(.552")	NA		
076	Sargent 7600 Integrallock (Enlarge Knob Hole)		(.552")	NA		

Cylinders with Other Manufacturer's Keyways

Type	Tailpiece / Keyway	Series	Lever (Plug diameter)	Knob (Plug diameter)	Tailpiece Part Number	Remarks
2400	033-C	CL3300/CL3600 (June 2000 and after) ED8200/ED8400	(.509")		622F328 (1.106")	Schlage C Keyway
	033-LA	CL3300/CL3600 (June 2000 and after) ED8200/ED8400	(.509")		622F328 (1.106")	Sargent LA Keyway
	034-C	CL3400 (Lockset Series Obsolete) CL3600 (Prior to June 2000)	(.509")		682F398 (0.950")	Schlage C Keyway
	034-LA	CL3400 (Lockset Series Obsolete) CL3600 (Prior to June 2000)	(.509")		682F398 (0.950")	Sargent LA Keyway
	037-C	CL3700	(.509")		685F098 (0.794")	Schlage C Keyway
		CK4700		(.509")		
	039-C	CL3900	(.509")		616F208 (1.700")	Schlage C Keyway
	039-LA	CL3900	(.509")		616F208 (1.700")	Sargent LA Keyway

Conventional Key Systems

Component (Key-in-Lever/Knob/Dead Bolt)

Cylinders for Other Manufacturers' Products (.552" Plug Diameter)

Type	Tailpiece	Series	Plug Diameter	Tailpiece Part Number (Length)	Remarks
4200	002-A47	Adams Rite® 4025 Pull	(.552")	146F788 (0.968")	Cylinder Only
	003-A47	Adams Rite 4025 Pull	(.552")	146F788 (0.968")	Cylinder and Housing

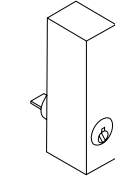

4200-003-A47

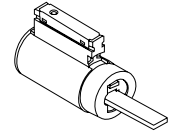

4200-002-A47

DL2100/DL3100 Deadbolts 6-Pin Cylinder (.509 Plug Diameter)

Function	Door Thickness							
	1 3/8"		1 3/4" (Standard)		2"		2 1/4"	
	Cylinder	Tailpiece	Cylinder	Tailpiece	Cylinder	Tailpiece	Cylinder	Tailpiece
DL2111 DL3111	4300-138-A2	689F848 (1.160")	4300-134-A2	689F848 (1.160")	4300-134-A2	689F848 (1.160")	4300-134-A1	686F208 (1.340")
DL2112* DL3112*								
DL2113 DL3113	4300-134-A1	686F208 (1.340")	4300-134-A1	686F208 (1.340")	4300-214-A2	689F868 (1.660")	4300-214-A2	689F868 (1.660")
DL2117 DL3117								

* Outside cylinder shown in table. Inside cylinder always 4300-000-A3-6 (no tailpiece)

DL2100/DL3100 Deadbolts 7-Pin Cylinder (.509 Plug Diameter)

Function	Door Thickness							
	1 3/8"		1 3/4" (Standard)		2"		2 1/4"	
	Cylinder	Tailpiece	Cylinder	Tailpiece	Cylinder	Tailpiece	Cylinder	Tailpiece
DL2111 DL3111	4300-138-A2-7	689F888 (0.785")	4300-134-A4-7	689F848 (1.160")	4300-134-A4-7	689F848 (1.160")	4300-134-A4-7	689F848 (1.160")
DL2112* DL3112*								
DL2113 DL3113	4300-134-A1-7	689F848 (1.160")	4300-134-A1-7	689F848 (1.160")	4300-214-A1-7	689F868 (1.660")	4300-214-A1-7	689F868 (1.660")
DL2117 DL3117								

* Outside cylinder shown in table. Inside cylinder always 4300-000-A3-7 (no tailpiece)

Conventional Key Systems

Rim

Rim Cylinders

For use with exit devices and exit device trim.



Type	Tailpiece Length	Pins	Keyway	Finish
3000	058 5/8" 955 and 959 Trims	5 6 (standard) 7	(see pages 31-39)	605
	138 1-3/8" M61 & M62 option for ED8200 and obsolete ED9200 exit device alarms			606
	200 2" (std. door)			611
	200N 2" ED4000/ED5000 Night Latch Function			612
	200V 2" vertical tailpiece			613
	312 3-1/2" (thick door)			622
	312V 3-1/2" vertical tailpiece			625
				626
	629			
	630			
	722			
Tailpiece Orientation std. = Horizontal V = Vertical				

Rim Thumbturn



Type	Tailpiece Length	Pins	Keyway	Finish
3300	138 1-3/8"	N/A	N/A	605
	200 2" (std. door)			606
				611
				612
				613
				622
				625
				626
				629
				630
				722

Interchangeable Core

Key Systems

Fast changeover - new security in seconds!

Options:

- 7-Pin
- VKC (Visual Key Control)
- CKC (Concealed Key Control)
- Construction Master Keying
- Restricted/Patented Keyways
- Pyramid



Interchangeable Core

Advantages

Rekeying can be done by non-technical personnel without removing hardware from the door. When used system-wide, IC provides tremendous rekeying convenience.

When planned from the inception of a system, IC cylinders can be integrated with conventional cylinders.

Applications

IC is recommended for virtually all types of keying systems, such as office buildings, hotels, schools, hospitals and universities. When used in exit devices and other installations which are labor intensive to rekey, IC saves time and money over the life of the building.

Operations

All operating keys (change, master, grand master) operate the lock normally. To rekey, use the special control key. The control key operates at a separate shear line in certain chambers within the core. Only the control key is required to remove and install a core.

Cores

6-pin standard; 7-pin, security and Pyramid optional. Two nickel silver change keys furnished standard per core. Control keys only furnished when ordered.

Key Control

Corbin Russwin cores are available with restricted keyways, patented keyways, security and Pyramid to deter unauthorized key duplication. No orders for patented keys, security or Pyramid keys will be shipped for a keying system without a letter of authorization from the end user.

Construction Keying

Corbin Russwin recommends temporary construction cores for greater security. Special construction master keying is also available, when planned from the inception of the keying system. See page 7 for details.

Core Marking

Concealed Key Control (CKC) is available for all Corbin Russwin cores. Visual Key Control (VKC) is available for conventional cores, but not for security or Pyramid cores.

Ordering IC Locksets and Exit Devices

For specific product availability and Quick Codes for cylinder options, see "How to Order" in each catalog section.

Interchangeable Core

How to Order

Key Systems

Interchangeable Core Mortise



Core	Function	Length	Cam	Pins	Keyway	Finish	Temporary Construction Core
3 Pyramid	0 Standard	114 1-1/4"	(see page 40)	6 (standard)	(see pages 31-39)	605	CT6 6-pin LFIC
4 SFIC Housing Only (No Core)	1 Uses - E1suffix for EMK blank Hotel 1-3/8"	138 1-3/8"	A01 Cloverleaf	7 (Not available for 1-1/4", 1-3/8" LFIC and 1-1/4" SFIC housings)		606	CT7 7-pin LFIC
8 Standard		112 1-1/2"	A02 Straight			611	CT6D 6-pin LFIC Disposable
9 Security (6-Pin only)		134 1-3/4"	A03 Adams Rite® MS and DL3000 Deadlock			612	CT7D 7-pin LFIC Disposable
7 LFIC Housing only (no core)	7 Pyramid Security		A04 DL4000			613	CTP Pyramid LFIC
			A05 Adams Rite 4070			622	CTPD Pyramid LFIC Disposable
			A06 Schlage® Cloverleaf			625	CT6SD 6-pin SFIC Disposable
			A07 DL4100			626	CT7SD 7-pin SFIC Disposable
			A93 Obsolete deadlocks: Corbin® 610 Series and Russwin® 1403 Series			629	
						630	
						722	

Interchangeable Core Rim

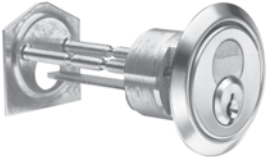

Core	Function	Tailpiece Length	Pins	Keyway	Finish	Temporary Construction Core
3 Pyramid	0 Standard	058 5/8"	6 (standard)	(see pages 31-39)	605	CT6 6-pin LFIC
4 SFIC Housing Only (No Core)	7 Pyramid Security	114 1-1/4" M61 & M62 option for ED8200 and obsolete ED9200 exit device alarms	7		606	CT7 7-pin LFIC
8 Standard		178 1-7/8" (std. door)			611	CT6D 6-pin LFIC Disposable
9 Security (6-Pin only)		178V 1-7/8" vertical tailpiece			612	CT7D 7-pin LFIC Disposable
7 Housing only (no core)		318 3-1/8" (thick door)			613	CTP Pyramid LFIC
		Tailpiece Orientation std Horizontal V Vertical (Not Available for 114 length)			622	CTPD Pyramid LFIC Disposable
					625	CT6SD 6-pin SFIC Disposable
					626	CT7SD 7-pin SFIC Disposable
					629	
					630	
					722	

Key Systems

Core Only



Description	Number	Remarks	EMK Blank
6-pin standard	8000	Set to hotel mortise EMK	N/A
6-pin standard	8000EMK	-E1 suffix	
Security	8010EMK	Set to hotel mortise EMK	N/A
Security	8010		-E1 suffix
7-pin	8000-7	Hotel indicator pin	N/A
6-pin for CL3329, CL3629	8001-034	Hotel indicator pin	-E8 suffix
7-pin for CL3329, CL3629	8001-034-7	Hotel indicator pin	-E8 suffix
6-pin for CK4229	8001-042	Hotel indicator pin	-E4 suffix
Security for CK4229	8011-042		-E4 suffix
Pyramid High Security	8020		N/A
Pyramid Security	8027		N/A

Specify Keyway

Finishes: 605, 606, 611, 612, 613, 622, 625, 626

Uncombined cores: Specify "UC". Not applicable for 8000EMK, 8010EMK

Key Systems

Standard Function Security Mortise



Mechanism	Function	Length	Cam (see page 40)	Pins	Keyway	Finish	Uncombined
1 Standard	0 Standard	118 1-1/8"	A01 Cloverleaf	6 -pin only	(see pages 31-39)	605	UC
9 IC (available)	1 Hotel	114 1-1/4"	A02 Straight			606	
1-1/4"	2 Blockout (No IC)	138 1-3/8"	A03 Adams Rite® MS and DL3000 Deadlock			611	
1-3/4"	4 Brink CW (No IC)	112 1-1/2"	A04 DL4000 Deadlock			612	
	5 Brink CCW (No IC)	134 1-3/4"	A05 Adams Rite 4070			613	
		200 2"	A06 Schlage® Cloverleaf			622	
		214 2-1/4"	A07 DL4100			625	
		212 2-1/2"	A92 Exit GripTrim 01 & 02			626	
			A93 Obsolete deadlocks: Corbin® 610 Series and Russwin® 1403 Series			629	
				630			
				722			

Special Function Security Mortise

Hotel Function Security Mortise

Change key and all normal master keys have limited rotation to retract latchbolt only. Emergency Master Key (EMK) and display key turn 360° for additional operation of deadbolt. EMK and display key requires 7-pin key blank for standard cylinders and -E1 suffix blank for IC cylinders.

Blockout Function Security Mortise

This is an access control feature used in applications where temporary blockage of all keys (master, change, etc.) is required. A simple turn of the Blockout Key to the 11 o'clock position blocks normal operation for as long as necessary. When normal access is again desired, insert the Blockout Key and turn it back to the 12 o'clock position. Integration of these cylinders must be planned from the inception of a keying system. Also available in rim version (see page 19).

Brink Function Security Mortise

This function was developed for the minimum security detention market. The change key turns only one direction while the master key turns both directions. Integration of these cylinders must be planned from the inception of a keying system.

Cylinder Number	Description
1011-114-A01*	1-1/4" Cloverleaf cam only
1091-138-A01	IC version 1-3/8"
1071-138-A01	IC housing only

*1011 cylinder not available with D1, D2, L1 or L2 keyways

Cylinder Number	Cam
1012-114-A01	Cloverleaf cam
1012-114-A02	Straight cam
1012-114-A03	DL 3000 Series Adams Rite® MS cam
1012-114-A04	DL4000 Series Deadlock
1012-114-A05	Adams Rite 4070
1012-114-A93	Obsolete 610/1403 Deadlock

Cylinder Number	Change Key	Cam
1014-118-A02	Clockwise	Straight
1015-118-A02	Counter-Clockwise	Straight
1014-118-A05	Clockwise	Brink "CKS"
1015-118-A05	Counter-Clockwise	Brink "CKS"

Folger Adam® NS400 Series x LEK uses A02 cam version.

Key Systems

Security Rim



Standard



Interchangeable Core

3	0	1	0	-	200	-	6	-	L4	x	Finish	x	Option
Mechanism	Function	Tailpiece Length		Pins	Keyway	Finish	Uncombined						
1 Standard 9 IC	0 Standard 2 Blockout (no IC)	For 3010 Only		6-pin only	(see pages 28-36)	605 606 611 612 613 622 625 626 629 630	UC						
		138	1-3/8" M61 & M62 option for ED8200 and obsolete ED9200 exit device alarms	114	1-1/4" M61 & M62 option for ED8200 and obsolete ED9200 exit device alarms								
		200	2" (Std. door)	178	1-7/8" (Std. door)								
		200V	2" vertical tailpiece	178V	1-7/8" vertical tailpiece								
		312	3-1/2" (thick door)	318	3-1/8" (thick door)								
		312V	3-1/2" vertical tailpiece										

Security Cores Only

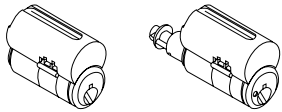

Description	Core Number	Remarks	EMK Blank
Standard	8010		N/A
For 1091	8010	EMK Set to hotel mortise EMK	-E1 suffix
For CK4229	8011-042	Hotel indicator pin	-E4 suffix

Specify Keyway. Available uncombined, except 8010EMK.
Finishes: 605, 606, 611, 612, 613, 622, 625, 626, 690

Key-in-Knob/Key-in-Lever

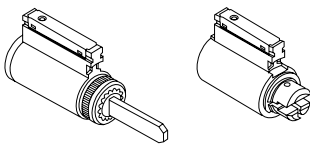

Lockset	Cylinder Number
CL3300, CL3500, CL3800, CL3600 Series (June 2000 and after)	2010-033
G1055 exit device knob trims	2010-033H
CL3300, CL3600 Series (Prior to June 2000)	2010-034
CL3800 Series (obsolete 1993-1997 model)	2010-038
CL3900 Series	2010-039
CL3900 Series (2", 2-1/4" Thick Door)	2010-039L
B2, G2 Exit Device Knob Trim	2010-051
CK4200 and UT5200 Series	2010-052
CK4229 Hotel Function	2011-052

Specify Keyway. Available uncombined.
Use -E4 suffix for EMK blank. Finishes: 606, 626

Other Manufacturers' Products

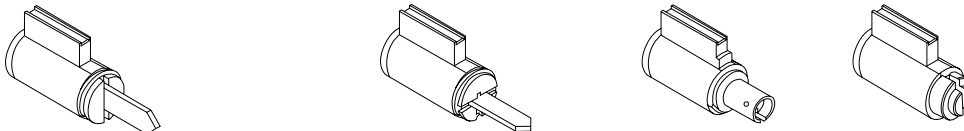

Vertical Tailpiece		Horizontal Tailpiece	
Alarm Lock DL2500 Series	2210-001-A21	Schlage D Series Knobs	2210-002-A21
Arrow® H Series Knobs & Levers	2210-001-A21	Schlage A Series Knobs (PLY, etc.)	2210-002-A22
Arrow Q Series Levers	2210-001-A21	Schlage A Series Knobs (ORB, only)	2210-002-A23
Sargent® 10 line (Enlarge lever hole)	2210-001-A21	Available Uncombined. Finishes: 606, 626	
Schlage® D Series Levers	2210-001-A21	Sargent 7, 8, 9 Line (enlarge knob hole)	2210-008
Schlage AL and ND Series Levers	2210-001-A22	Yale® 5400, 6200 Knobs (enlarge knob hole)	
Lockwood H Series Knobs (enlarge knob hole)	2210-003-A24	2210-054	

Master Ring Key Systems

Features and Benefits

- **Greater master keying capacity**
- **Superior keying flexibility**
- **Greater security in each cylinder**

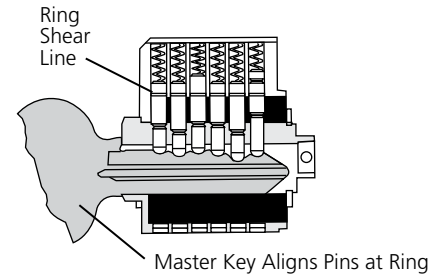
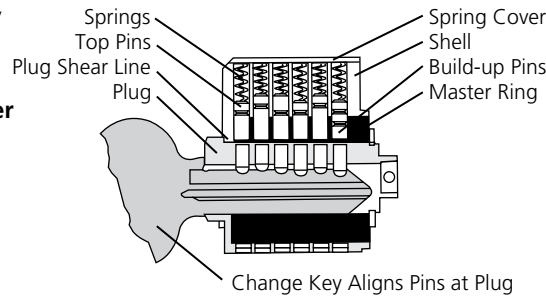

Advantages

6-pin Master Ring keying systems offer keying capacity similar to 7-pin conventional cylinder systems.

There is, however, far greater flexibility for asymmetrical keying systems, because change key combinations do not require any direct relationship to those of master keys. In conventional systems, combinations not needed under a given master key cannot be used elsewhere in the system. In master ring, they can. This frees thousands of combinations for use anywhere within a master ring system.

Since the master keys all have their own shear line, fewer master pins are used, increasing cylinder security. This security enhancement reduces the chances of cylinders being manipulated by stray keys. It also hinders surreptitious entry by picking and impressing.

When planned from the inception of a keying system, conventional cylinders may be integrated into specific parts of a Master Ring system for areas where the required hardware does not accommodate the large Master Ring cylinders.

Applications

Corbin Russwin Master Ring cylinders are especially recommended for installations which require large and complicated keying systems, such as hospitals and universities.

Field Serviceability

Corbin Russwin Master Ring cylinders are fully field serviceable.

Key Control

Restricted and patented keyways are available. Patented keyways require a letter of authorization from the end user listing exact quantities for all orders of cylinders, keys or key blanks.

Construction Master Keying

When planned from the inception of a keying system, construction master keying is available.

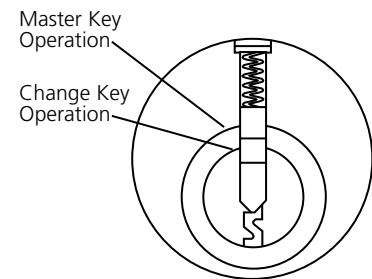

Operation

The change key rotates the cylinder plug only. Master keys operate at the master ring, which is a sleeve around the plug.

Cylinder Marking

Visual Key Control (VKC) and Concealed Key Control (CKC) are available for Master Ring cylinders.

Ordering Locksets and Exit Devices with Master Ring Cylinders

For specific product availability and Quick Codes for cylinder options, see "How to Order" in each catalog section.

Master Ring Key Systems

How to Order

Standard Master Ring Mortise

(1-1/2" diameter; .552" diameter plug)



Type	Length	Cam	Pins	Keyway	Finish
1060	100 1" (5-pin only)	(see page 40)	5	(see pages 31-39)	605
	118 1-1/8"	A61 Cloverleaf*	6 (standard)		606
	114 1-1/4"	A62 Straight	7 (Available 1-3/8" only)		611
	138 1-3/8"	A63 Large Short		612	
	112 1-1/2"	A64 Large Long			613
	134 1-3/4"	A65 Cloverleaf (formerly 11A)			618
	200 2"				619
	214 2-1/4"				622
	212 2-1/2"	*A61 is for locks made after 5/93; requires thumbturn hub			625
	234 2-3/4"				626
	300 3"	562F41-2			722

Flexible Head Master Ring Mortise

(1-1/2" diameter; .552" diameter plug)



Type	Length	Cam	Pins	Keyway	Finish
1160	100 1" (6-pin only)	(see page 40)	5	(see pages 31-39)	605
	118 1-1/8"	A61 Cloverleaf*	6 (standard)		606
	114 1-1/4"	A62 Straight			611
		A63 Large Short			612
		A64 Large Long			613
		A65 Cloverleaf (formerly 11A)			618
					619
		*A61 is for locks made after 5/93; requires thumbturn hub			622
					625
					626
		562F41-2			722

Dummy Master Ring Mortise



Cylinder Number	Length
1460-118	1-1/8"
1460-114	1-1/4"
1460-138	1-3/8"
1460-112	1-1/2"

Finishes: 605, 606, 611, 612, 613, 618, 619, 622, 625, 626, 722

Master Ring Rim

(1-1/2" diameter; .552" diameter plug)



Cylinder Number	Description
3060-200	Standard horizontal tailpiece
3060-312	Thick door, horizontal tailpiece
3060-200V	Vertical tailpiece
3060-312V	Thick door, vertical tailpiece

Finishes: 605, 606, 611, 612, 613, 618, 619, 622, 625, 626, 722

CK4200 & UT5200 Series Lockset

Specify keyway (.552" diameter plug)

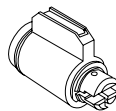
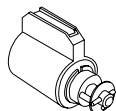
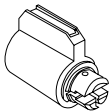

Standard Cylinder 2060-052	With Indicator Pin for CK4229 Hotel 2061-042	Discount, Ronde & Continental Knob 2160-052	For ED6800 x B5 or B6 For ED7400 x O3 or O4 4266-001-A02	For ED6800 x O1 or O2 4266-001-A92
Finishes: 606, 626			Finishes: 606, 626	

Exit Device Operators

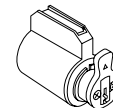
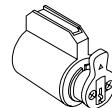

Key Systems

Description

Pyramid, Corbin Russwin’s patented security cylinder, is the most secure locking system available. Pyramid cylinders are available in both high security and security versions. The high security version is certified by Underwriters Laboratories to UL437 standards.

Applications

Especially recommended for installations requiring superior protection against picking, drilling and other surreptitious entry. Ideally suited for Educational and Healthcare facilities, Industrial and Commercial buildings.

System Administration & Key Control

Key control will be maintained through compliance with Corbin Russwin’s Security Policy: for a copy contact Key Systems Administration or visit our web site at www.corbinrusswin.com. A Pyramid owner’s binder will be forwarded directly to the designated systems administrator with each new system. Included in this binder are catalogs as well as system-specific, sequentially coded registration certificates. A registration certificate must accompany each order that is submitted to Corbin Russwin.

Product Specification

All cylinders shall employ a patented locking mechanism that requires the use of a patented key and is furnished with a minimum of 7 pins. High Security cylinders shall meet the requirements of UL437. Interchangeable cores shall meet the drill resistance and pick resistance of UL437.

Keys shall be nickel silver and furnished with a large bow.

Certifications

BHMA A156.5 Grade-1

E09211A* (Mortise)

E09221A* (Rim)



1. UC cylinders are supplied, less keys, pins, springs and pin covers.
2. When cylinders are ordered with locks.
3. Pyramid cores to be ordered as a separate line item.

Features	Benefits
<ul style="list-style-type: none"> • Utility patent 6,125,674 (expiring 2018) 	<ul style="list-style-type: none"> • The ultimate protection against unauthorized key duplication
<ul style="list-style-type: none"> • Available with high-security protection (UL437) 	<ul style="list-style-type: none"> • Underwriters Laboratory listing for resistance to picking & drilling
<ul style="list-style-type: none"> • 7-pin 	<ul style="list-style-type: none"> • Greater master keying capabilities • Uses existing 6-pin interchangeable core housings • 1-1/4" (32mm) length for mortise cylinders
<ul style="list-style-type: none"> • Available with stainless steel pins 	<ul style="list-style-type: none"> • Drill and pick resistant
<ul style="list-style-type: none"> • Large key bow 	<ul style="list-style-type: none"> • Easy handling & special stamping options
<ul style="list-style-type: none"> • Thicker and stronger nickel silver keys 	<ul style="list-style-type: none"> • Ideally suited for high usage & abusive applications
<ul style="list-style-type: none"> • User friendly 	<ul style="list-style-type: none"> • No expensive dedicated equipment necessary for key cutting

E09231A* (Bored Lock Cylinders)
*A (suffix) refers to cylinders of pick and drill resistance.

UL Underwriters Laboratories Inc.
(UL437)BP8976
1020, 2020, 3020 Fixed Core (FC) series only

Finishes

Pyramid cylinders are available in all Corbin Russwin standard finishes.

Keying

7 pin with two nickel silver change keys per cylinder. Pyramid cylinders may be uncombined (specify UC)¹, master or grand master keyed to a specific facility.

Keys shipped separately for master keyed cylinders.

System Specifications

- Pyramid systems are independent and cannot be keyed into existing and/or conventional systems.
- Pyramid cylinders are to be keyed to factory-generated bittings only.
- Cross keying is not available.

Key Discard Policy & Warranty

See page 49.

Construction Master Keying

Pyramid cylinders are not available construction master keyed. Interchangeable core jobs can be furnished with temporary construction cores. Temporary construction cores will be unrelated to the permanent system’s master key. When the permanent cores are installed, the temporary construction cores are returned to Corbin Russwin for credit.

How to Order Example

1. Mortise lock with temporary construction core
Qty. - ML2051 - LSA - 626 - RHR - CTP
2. Mortise cylinder with temporary construction core
Qty. - 1080-114-A01-626-CTP
3. Permanent core ordered separately
Qty. - AA1 - 8020 - 626

Pyramid Quick Codes²

- PS Pyramid Security Fixed Core
- PCS Pyramid Security Interchangeable Core
- PHS Pyramid High Security Fixed Core
- PCHS Pyramid High Security Interchangeable Core
- CTP³ Pyramid with Temporary Construction Core
- CLP³ Pyramid Less Core

Key Systems

Performance Features

Shell

- Locking pin mechanism
- Hard metal inserts

Key

- Control pin

Plug

- Blocking plate
- Hard metal inserts

Pins & Springs

- Hardened stainless steel pick-resistant bottom pins*
- Hardened stainless steel pick-resistant top pins*
- Hardened stainless steel pick-resistant master pins (if required)*
- Hardened stainless steel pick-resistant build-up pins (if interchangeable core)*
- Springs

Collar

- Solid recessed (mortise)

* Hardened stainless steel pins used for UL437 High Security versions only. Pyramid Security version uses nickel silver bottom pins and brass master, build-up and top pins.

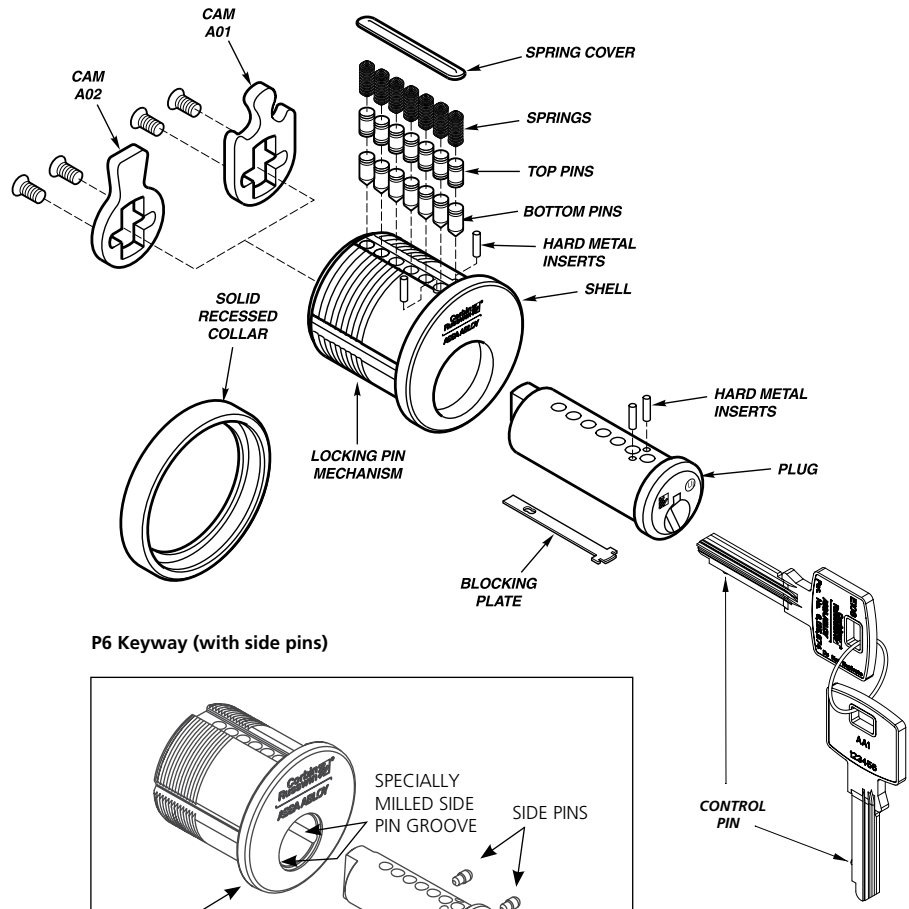

Operation



Without Key

Locking pin mechanism engages blocking plate and prevents the plug from turning.

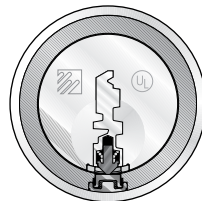



With Key

Key's control pin depresses the locking pin mechanism and allows the plug to turn.

Key Systems

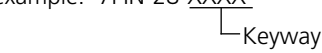
Keys

- Nickel silver
- Key Bow Type 28
- Ordering example: 7PIN-28-XXXX

- Ordering example P6 Keyway:
 7PIN-28-XXXX-SPCXX

Back Side Stamping & Options

- Key set (VKC1), standard – unless otherwise indicated
- System registry number will be stamped on upper-level keys unless otherwise indicated
- Concealed key control (CKC2) available on cylinders
- Visual key control (VKC2 and VKC3) not available on cylinders. CKC3 also not available.

Note: Refer to Corbin Russwin's general catalog and price book for complete detailed information.

Keyway Security

Pyramid keyways will be determined by the supervisor of Key Systems Administration. Assignment will be based on the overall system requirements and geographic location to provide maximum protection to the owner. For security reasons, the keyway profiles are not shown.

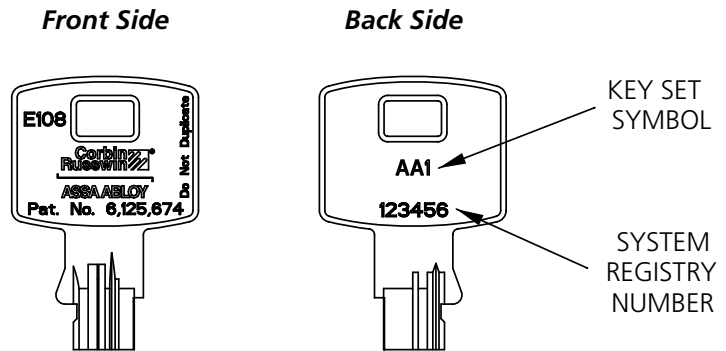

Key Systems

Mortise Cylinders

Mortise Locks/Deadlocks

Mortise Locks/Deadlocks

For use with all Corbin Russwin ML2000, ML2000HS and ML2200 (discontinued) mortise locks. DL4000 & DL3000 Series Deadlocks.



Conventional
Fixed Core
(FC)



Interchangeable Core
(IC)

Mortise Exit Devices

For use with ED7600 and ED6600 devices.

Type	Length	Cam	Finish
1020 - High Security Mortise	1020/1027 - Non-IC (Fixed Core) 114 - 1-1/4" (32mm) 112 - 1-1/2" (38mm) *See note #3	A01 - Cloverleaf	605 - Bright Brass
1027 - Security Mortise		A02 - Straight	606 - Satin Brass
1030 - High Security IC Mortise complete	1030/1037/1070 IC 114 - 1-1/4" (32mm) 138 - 1-3/8" (35mm) 112 - 1-1/2" (38mm) 134 - 1-3/4" (44mm)	A03 - Adams Rite® MS	611 - Bright Bronze
1037 - Security IC Mortise complete		A04 - DL4000 Series	612 - Satin Bronze 613 - Dark Oxidized Satin Bronze - oil rubbed
1070 - Housing only		A05 - Adams Rite® 4070	618 - Bright Nickel Plated
		A06 - Schlage® Cloverleaf	619 - Satin Nickel Plated
		A07 - DL4100	622 - Flat Black Coated
	A62 - 900 KRM Straight	625 - Bright Chromium Plated	626 - Satin Chromium Plated
	A92 - See note #1	629 - Bright Stainless Steel	630 - Satin Stainless Steel
	A93 - See note #2		722 - Black oxidized bronze, oil rubbed

Note #1 - Not available IC

Note #2 - For obsolete Corbin® 610 and Russwin® 1403 series deadlocks

Note #3 - For ML2000 applications with door thickness exceeding 2-1/2" up to 3" in thickness, use IC cylinders.

How to Order Examples

High Security Mortise Cylinder Ordered Separately

Quantity	Keyset	Cylinder	Length	Cam	Finish
50	AA1	1020	114	A01	605

Mortise Cylinder with a Pyramid Security Interchangeable Core

Quantity	Keyset	Cylinder	Length	Cam	Finish
50	AA1	1037	114	A01	605

Mortise Lock with a Pyramid Fixed Core High Security Cylinder

Quantity	Keyset	Series/Function	Trim	Finish	Hand	Pyramid Quick Code
50	AA1	ML2051	LSA	626	RHR	PHS (PS for Security version)

Mortise Lock with a Pyramid Interchangeable Core High Security Cylinder

Quantity	Keyset	Series/Function	Trim	Finish	Hand	Pyramid Quick Code
50	AA1	ML2051	LA	626	RHR	PCHS (PCS for Security version)

Exceptions

Pyramid cylinders are not available for the following: ML2029, ML2029HS, ML2029VR, ED7600 - applications over 2-1/4" thick, ED6600 - applications over 1-3/4" thick.

Key Systems

Rim Cylinders

For use with exit devices and exit device trims.

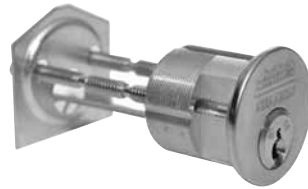

Conventional Fixed Core (FC)



Interchangeable Core (IC)

Type	Length	Availability		Finish
		FC	IC	
3020 - High Security Rim Cylinder	058-5/8" (16mm) Tailpiece	X	X	605 - Bright Brass
	114 - 1-1/4" (32mm) M61 & M62 option for ED8200 and ED9200 exit device alarms		X	606 - Satin Brass 611 - Bright Bronze
	138 - 1-3/8" (35mm) M61 & M62 option for ED8200 and Obsolete ED9200 exit device alarms	X		612 - Satin Bronze 613 - Dark Oxidized Satin Bronze - oil rubbed
	178 - 1-7/8" (48mm) (Std. Door)		X	618 - Bright Nickel Plated
	178V - 1-7/8" (48mm) vertical		X	619 - Satin Nickel Plated
	200 - 2" (51mm)	X		622 - Flat Black Coated
	200N - 2" (51mm) ED4000/ED5000 Night Latch Function	X		625 - Bright Chromium Plated
	200V - 2" (51mm) vertical	X		626 - Satin Chromium Plated
	312 - 3-1/2" (89mm)	X		629 - Bright Stainless Steel
	312V - 3-1/2" (89mm) vertical	X		630 - Satin Stainless Steel
3027 - Security Rim Cylinder	178 - 1-7/8" (48mm) (Std. Door)		X	722 - Black oxidized bronze, oil rubbed
3030 - High Security IC Rim Cylinder	200 - 2" (51mm)	X		
3037 - Security IC Rim Cylinder	200N - 2" (51mm) ED4000/ED5000 Night Latch Function	X		
3070 - Housing only	200V - 2" (51mm) vertical	X		
	312 - 3-1/2" (89mm)	X		
	312V - 3-1/2" (89mm) vertical	X		
	318 - 3-1/8" (79mm)		X	

How to Order Examples

High Security Rim Cylinder Ordered Separately

Quantity	Keyset	Cylinder	Length	Finish
50	AA1	3020	200	605

Rim Cylinder with a Pyramid Security Interchangeable Core

Quantity	Keyset	Cylinder	Length	Finish
50	AA1	3037	178	605

Exit Device with a Pyramid Fixed Core High Security Cylinder

Quantity	Keyset	Series/Function	Trim	Finish	Hand	Pyramid Quick Code
50	AA1	ED5200	L955	630	RHR	PHS (PS for Security version)

Exit Device with a Pyramid Interchangeable Core High Security Cylinder

Quantity	Keyset	Series/Function	Trim	Finish	Hand	Pyramid Quick Code
50	AA1	ED5200	L955	630	RHR	PCHS (PCS for Security version)

Key Systems

Key-in-Lever / Knob Cylinder

For use with Corbin Russwin CL3300, CL3500, CL3700, and CL3800 lever locks, CK4200 and CK4700 knob locks and UT5200 unit locks. 2020/2027 series cylinders can also be used on CL3400, CL3600, CL3800 and CL3900 (discontinued) locks.



Conventional
Fixed Core
(FC)



Interchangeable Core
(IC)

Type	Lockset Series	Finish
2020 - High Security Key-in-Lever/Knob	033 - CL3300, CL3500, CL3600 (June 2000 and after) and CL3800 Lever	606 - Satin Brass 626 - Satin Chromium Plated
	033H - G10 Exit Device Knob Trim	
	034 - CL3400 Lever - CL3600 Lever (Before June 2000) A5, N5 Obsolete ED8000 Trims	
	037 - CL3700 Lever - CK4700 Knob	
2027 - Security Key-in-Lever/Knob	038 - CL3800 Lever (Manufactured 1993-1997)	626 - Satin Chromium Plated
	039 - CL3900 Lever (1-3/8" - 1-3/4" door)	
	039L - CL3900 Lever (2" - 2-1/4" door)	
	051 - G3 Exit Device Knob Trim	
	052 - CK4200 Knob - UT5200 Knob and Lever	

Key-in-Lever/Knob for other Manufacturers' Products

Cylinder Descriptions			
High Security (PHS)	Security (PS)	Tailpiece Orientation	Used for:
2220-001-P21	2227-001-P21	Vertical	Schlage® D Series Levers Arrow H® Series Knobs and Levers Sargent® 10 line (Enlarge Lever Hole)
2220-002-P21	2227-002-P21	Horizontal	Schlage® D Series Knobs
2220-001-P22	2227-001-P22	Vertical	Schlage® AL and ND Series Levers
2220-002-P22	2227-002-P22	Horizontal	Schlage® A Series Knobs (Ply, etc.)
2220-002-P23	2227-002-P23	Horizontal	Schlage® A Series Knobs (ORB only)

How to Order Examples

High Security Component Cylinder Ordered Separately

Quantity	Keypad	Cylinder	Lockset Series	Finish
50	AA1	2020	033	626

Cylindrical Lock with a Pyramid Fixed Core High Security Cylinder

Quantity	Keypad	Series/Function	Trim	Finish	Pyramid Quick Code
50	AA1	CL3357	PZD	626	PHS (PS for Security version)

Cylindrical Lock with a Pyramid Interchangeable Core High Security Cylinder

Quantity	Keypad	Series/Function	Trim	Finish	Pyramid Quick Code
50	AA1	CL3357	PZD	626	PCHS (PCS for Security version)

Exceptions

Pyramid cylinders are not available for the following: CL3329, CL3629, CK4229, CK4451, CK4455, CK4457, CK4429, CK4482, DL2100 series, DL3100 series.

Pyramid

Interchangeable Core

Key Systems

Interchangeable Core

For use with Corbin Russwin's 6-pin Interchangeable Core housings & shells.*



Type	Finish
8020- High Security IC core*	605
	606
	611
8027- Security IC core*	612
	613
	622
	625
	626
	722

* **Note:** Corbin Russwin 6-pin Interchangeable Core housings 1070 (mortise) & 3070 (rim) will accept 8020/8027 cores.

How to Order Examples

Security Interchangeable Core Ordered Separately

Quantity	Keypad	Cylinder	Finish
50	AA1	8027	605

Padlocks

Used with Pyramid Interchangeable Cores. PL5030, PL5130, PL5037, PL5137

How to Order Examples

Padlock with a Pyramid High Security(8020) Interchangeable Core Cylinder

Quantity	Keypad	Series/Function	Shackle Length
50	AA1	PL5030	258

*Refer to general catalog for miscellaneous options.

Padlock with a Pyramid Security(8027) Interchangeable Core Cylinder

Quantity	Keypad	Series/Function	Shackle Length*
50	AA1	PL5037	258



Deadlocks

Used with Pyramid mortise cylinders. (DL3000 and DL4000) Available in all standard finishes.

How to Order Examples

Deadlock with a Pyramid Fixed Core High Security Cylinder

Quantity	Keypad	Series/Function	Finish	Hand	Pyramid Quick Code
50	AA1	DL4013	626	RHR	PHS (PS for Security version)

Deadlock with a Pyramid Interchangeable Core High Security Cylinder

Quantity	Keypad	Series/Function	Finish	Pyramid Quick Code
50	AA1	DL4013	626	PCHS (PCS for Security version)

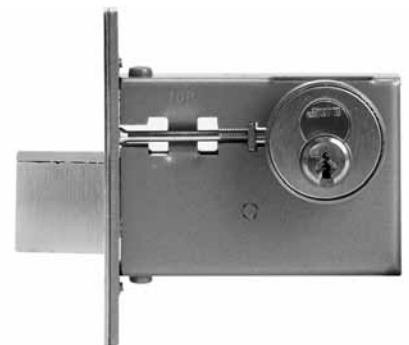

Bump Resistant Cylinders

Key Systems

Protect your building from unwanted entry with Corbin Russwin bump-resistant cylinders. Our bump-resistant cylinders deter bumping without compromising the cylinder's structural integrity and strength. This option is available with Corbin Russwin conventional and Pyramid patented security and high-security cylinders on our mortise, cylindrical and exit device hardware.

Recently, a lot of information has been circulating about bumping, a technique used to defeat cylinders. Although this method has been around for a number of years, the internet has increased public awareness. Bumping is when a "bump key" is inserted into the cylinder and struck using a mallet or hammer type object. The bump key is specifically designed to transfer the energy from the force of the blow to create a separation in the cylinder's pins which compromises the lock allowing it to open.

Although BHMA has yet to establish bump-resistance standards, Corbin Russwin Bump Resistant Cylinders were tested and verified by an independent testing lab. They conclusively resisted bumping attack and did not allow entry. Verification and testing data is available upon request.

Bump-Resistant Cylinders:

- Specify "BRP"

Retrofit:

- Convert existing cylinders with Bump-Resistant Top Spool Pins

Features

Bump-resistant cylinders are designed for use with all Corbin Russwin locking hardware:

- Cylindrical locks
- Mortise locks
- Exit devices
- Access control locks
- Unit locks
- Auxiliary locks

Factory bitted, a symbol BRP is stamped onto pin cover/slides. Interchangeable core cylinders are not available with bump-resistant pinning.



BRP pinned mortise cylinder



BRP pinned rim cylinder



BRP pinned key-in-lever cylinder

Bump-Resistant Top Spool Pins

Description	Part Number	Qty
Conventional	628F10-7-171	Vials of 100 pcs.
Pyramid A	628F10 - 7 - 142	Vials of 100 pcs.
Pyramid C	628F10 - 7 - 236	Vials of 100 pcs.

L4	-	6-Pin	-	1	-	0
Key Sections (see pages 31-40)	Length Indicate 5-, 6-, 7-pin		Bow Shape 1 Standard 5 Large 9 Security	Bow Marking 0 Coined Logo 1 Plain 2 DND 3 US property DND 8 Patented DND 9 Restricted DND		

Standard Bows



10
The standard bow furnished for all non-restricted keyways unless otherwise specified. The other side is blank.
Example: L4-6PIN-10.

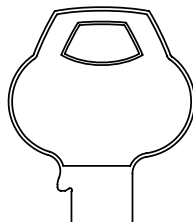

11
Blank both sides, for use when more area is required for stamping, such as custom die stamps. Not for use with restricted keyways.
Example: L4-6PIN-11.

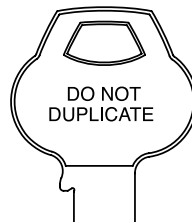

12
This bow enhances key control for non-restricted Corbin Russwin keyways. Other side blank. Example: L4-6PIN-12.



13
For use only on U.S. Government projects.
Example: L4-6PIN-13.

Restricted Keys

10, 50 and 90 bow shapes are designated as 19, 59 and 99 for restricted keyways. They are stamped this way on the thumb side. Other side blank.

RESTRICTED
DO NOT
DUPLICATE

This stamp is not available for keys which are not restricted.

Large Bows

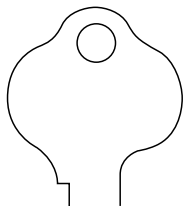

51
Blank both sides. Recommended for special die stamps or large amounts of stamping, and for Control and Emergency Master Keys. Not available for 752, 852 or A Class keyways.
Example: L4-6PIN-51.

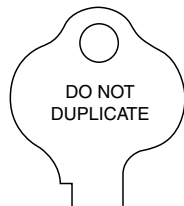

52
Recommended for non-restricted keys which need extra space for stamping. This bow also enhances key control for other Corbin Russwin keys. Not available for 752, 852 or A Class keyways.
Example: L4-6PIN-52.



53
For use only on U.S. Government projects. Recommended for use when a large amount of stamping is required. Not available for 752, 852 or A Class keyways.
Example: L4-6PIN-53.

Patented Keys

10, 50 and 90 bow shapes are designated as 18, 58 and 98 for patented keyways. They are stamped this way on the thumb side. Other side blank.

PATENTED
DO NOT
DUPLICATE

This stamp is not available for keys which are not patented.

Security Bows (Inactive - for Existing Systems Only)

- | | | | |
|---|---|---|---|
| <p>90
Standard bow for security keys. Example: L4-6PIN-90.</p> | <p>91
Blank both sides for security keys where extra stamping is required. Not for use with restricted or patented keyways. Example: L4-6PIN-91.</p> | <p>92
This bow enhances key control for non-restricted or patented security keys. Other side blank. Example: L4-6PIN-92.</p> | <p>93
For use only on security keys for U.S. Government projects. Example: L4-6PIN-93.</p> |
|---|---|---|---|

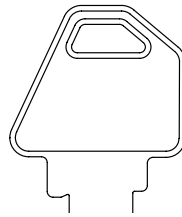

Hotel Security Key Blanks

Standard hotel function mortise cylinders 1001 and 1011 use 7-pin Emergency Key blanks. The 51 bow is suggested e.g., L4-7PIN-51. All other Corbin Russwin hotel function cylinders require keys with a special undercut tip. The four variations are shown below.

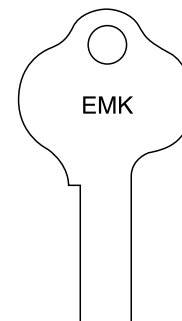
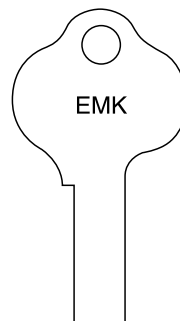
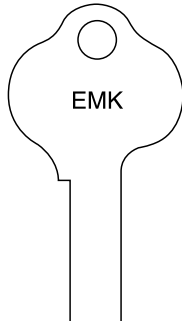
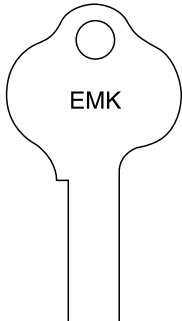

- | | | | |
|---|--|---|---|
| <p>-E1 Suffix
For interchangeable core mortise cylinder 1081 (conventional) and 1091 (security). Available 6-pin only. Examples: L4-6PIN-51-E1 or L4-6PIN-90-E1.</p> | <p>-E8 Suffix
For CL3329 and CL3629 and obsolete CL3429 key-in-lever locksets, fixed core and IC. Available 6- and 7-pin. Example: L4-6PIN-51-E8.</p> | <p>-E4 Suffix
For CK4229 locksets, fixed core and IC, conventional and security. Also for CK4429. Available 5- or 6-pin. Examples: L4-6PIN-51-E4 or L4-6PIN-90-E4.</p> | <p>-E5 Suffix
For obsolete 1429, 3333EM, 4333EM and 5629 key-in-knob locksets. Available 5- and 6-pin. Example: L4-6PIN-51-E5.</p> |
|---|--|---|---|

Pyramid Bow

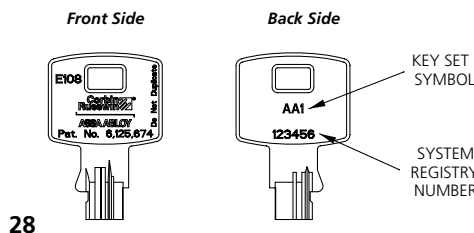

28
Standard bow furnished for all Pyramid keys.

Ordering Example

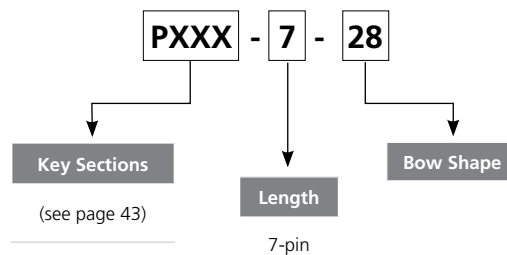

Key Systems

Multiplex/Simplex Keyways

Multiplex keyways can be used together to expand a keying system. A simplex keyway is independent, stands alone and cannot be tied into any other keyway to expand a keying system.

All/Multi-Section/Single Section Keys

All/Multi-section keys can be used on more than one cylinder with different sections. For example: a key cut on the L41 multi-section keyblank will pass cylinder in the L1, L2, L3 and L4 keyways. Single section keys can be used with cylinders of the same section. For example: a key cut on the L4 single section keyblank will only pass a cylinder in the L4 keyway.

Active Keyways

Keyways which are available for new Corbin Russwin keying systems are considered active. In the case of new master key systems, the factory reserves the right to select the keyway from a range of standard keyways, based on usage in a particular geographical area.

Inactive Keyways

Many older Corbin Russwin keyways are designated inactive. **No new systems** shall be established on these keyways. However, they continue to be available to support existing keying systems.

Restricted Keyways

New systems on restricted keyways require prior approval of Corbin Russwin Key Systems Administration. For security reasons, these keyway profiles are not shown.

Patented Keyways

New systems on patented keyways require prior approval of Corbin Russwin Superior of Key Systems Administration. Patented keyways are available for jobs which require protection against unauthorized duplication and require an agreement to be signed between Corbin Russwin and the end user.

Keyblank, cylinders and plugs with patented keyways are only supplied to distribution when a proper letter of authorization from the end user accompanies the purchase order. For security reasons, these keyway profiles are not shown.

Pyramid Keyways

Pyramid keyways are only available for Pyramid cylinders and separate specifications are used from conventional Corbin Russwin keying systems. New systems for Pyramid require a Notice of Acceptance document to be on file with Key Systems Administration. All orders for Pyramid must have a system specific Registration Certificate attached and all products must ship directly to the end user unless a quantity - specific Letter of Authorization accompanies the purchase order. For security reasons, these keyway profiles are not shown.

Bitting Classes

Corbin Russwin has several sets of dimensional standards for bitting (cutting) keys. If the wrong specifications are used when making keys on code machines in the field, they will not operate in conjunction with factory supplied cylinders and keys. The bitting class is given for each group of keyways. All bitting specs are available in the Corbin Russwin cylinder manual.

L Series (Corbin Russwin)

4 keyway multiplex system.
Available 5-, 6- and 7-pin.
Z Class bitting.
Reverse of D Series.



All-Section Key
Multi-Section Key
Cylinder Keyway and
Single Section Key

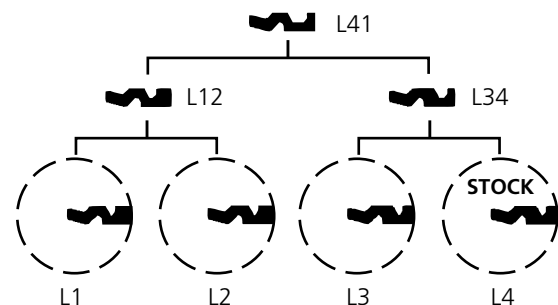

D Series (Russwin®)

4 keyway multiplex system.
Available 5-, 6- and 7-pin.
DH Class bitting.
Reverse of L Series.

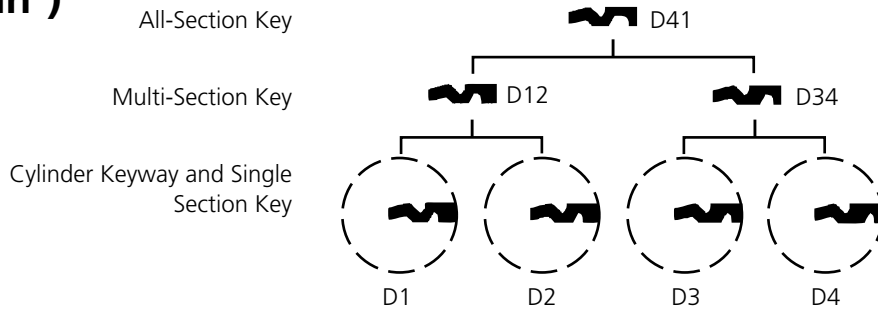

59 Series (Corbin®)

9 keyway multiplex system.
Available 5-, 6- and 7-pin.
Z Class bitting.

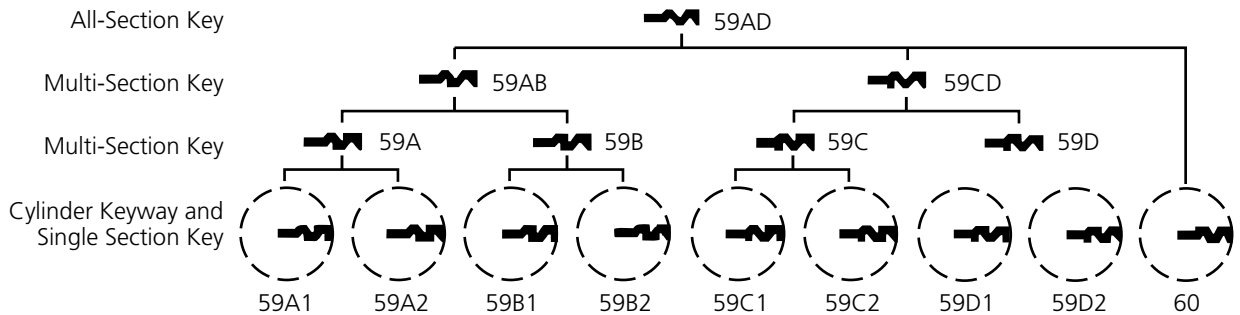

H Series (Russwin)

8 keyway multiplex system.
Available 5-, 6- and 7-pin.
DH Class bitting.

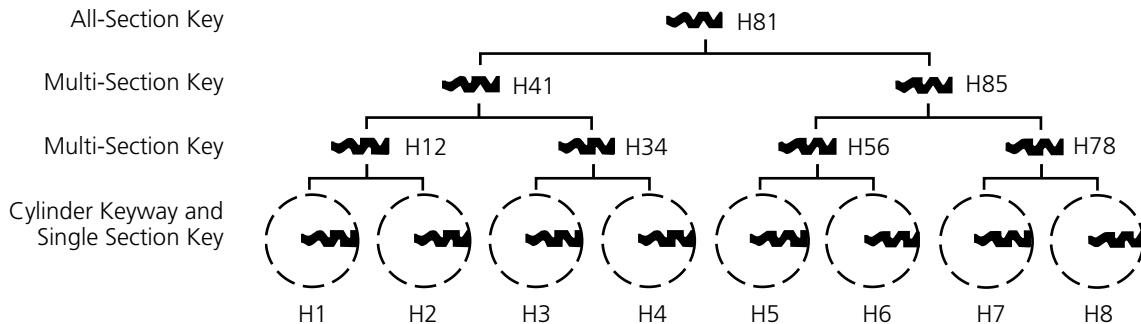

70 Series (Corbin)

Simplex Keyway.
Z Class bitting.
Reverse of 60.

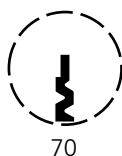

Key Systems

62 Series (Restricted)

Keyway profiles not shown for security reasons.
8 keyway multiplex system.
Available 5-, 6- and 7-pin.
Z Class bitting.

- All-Section Key
- Multi-Section Key
- Multi-Section Key
- Cylinder Keyway and Single Section Key

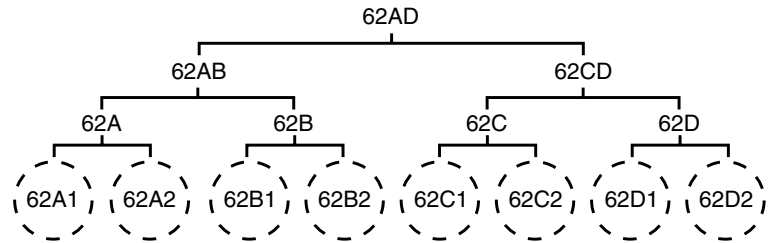

Security



Available

HO Series (Restricted)

Keyway profiles not shown for security reasons.
8 keyway multiplex system.
Available 5-, 6- and 7-pin.
DH Class bitting.

- All-Section Key
- Multi-Section Key
- Multi-Section Key
- Cylinder Keyway and Single Section Key

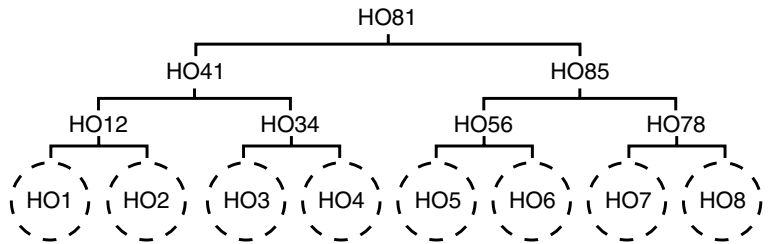

Security



Available

Keyways

Key Systems

93 Series (Protected)

Keyway profiles not shown for security reasons.
8 keyway multiplex system.
Available 5-, 6- and 7-pin.
Z Class bitting.

- All-Section Key
- Multi-Section Key
- Multi-Section Key
- Cylinder Keyway and Single Section Key

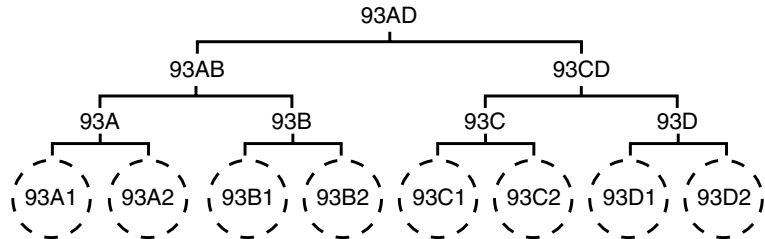

Security



Available

39 Series (Protected)

Keyway profiles not shown for security reasons.
8 keyway multiplex system.
Available 5-, 6- and 7-pin.
Z Class bitting.

- All-Section Key
- Multi-Section Key
- Multi-Section Key
- Cylinder Keyway and Single Section Key

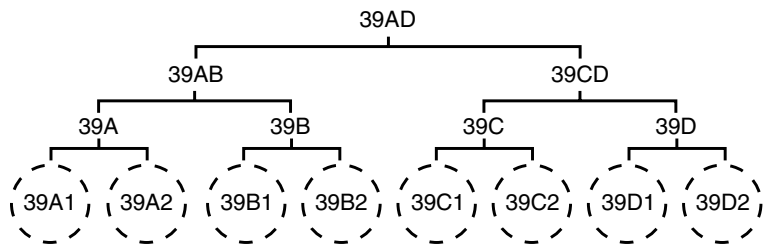

Security



Available

F Series (Protected)

Keyway profiles not shown for security reasons.
4 keyway multiplex system.
Available 5-, 6- and 7-pin.
Z Class bitting

- All-Section Key
- Multi-Section Key
- Cylinder Keyway and Single Section Key

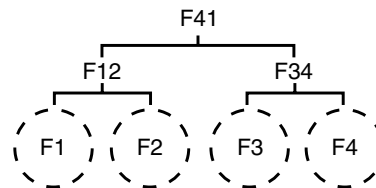

Security



Available

J Series (Protected)

Keyway profiles not shown for security reasons.
4 keyway multiplex system.
Available 5-, 6- and 7-pin.
Z Class bitting.

- All-Section Key
- Multi-Section Key
- Cylinder Keyway and Single Section Key

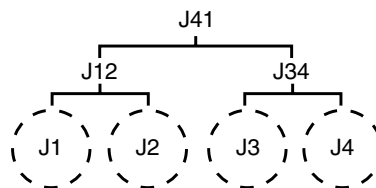

Security



Available

Keyways

Corbin® X Class

Key Systems

57 Series

8 keyway multiplex system. All-Section Key
Available 5-, 6-, and 7-pin.
X Class bitting.

Reverses

57A1	27B2
57A2	27B1
57B1	27A2
57B2	27A1

Multi-Section Key

Multi-Section Key

Cyl. Keyway and
Single Section Key

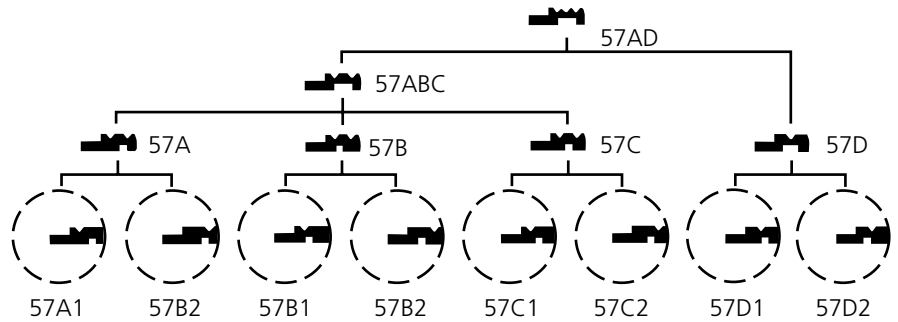

Security



Not Available

Simplex Keyways

6 independent keyways.
Available 5-, 6- and 7-pin.
X Class bitting.

Security



Not Available

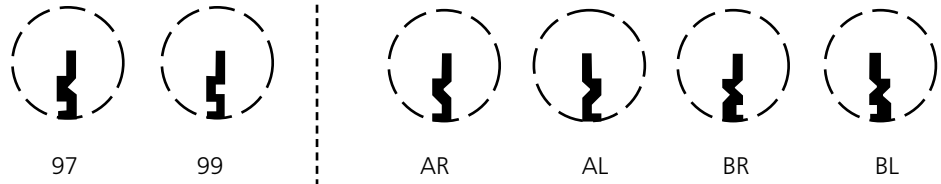

Key Systems

27 Series

7 keyways total (5 active).
Available 5-, 6- and 7-pin.
X Class bitting.

Reverses

27A1 57B2
27A2 57B1
27B1 57A2
27B2 57A1

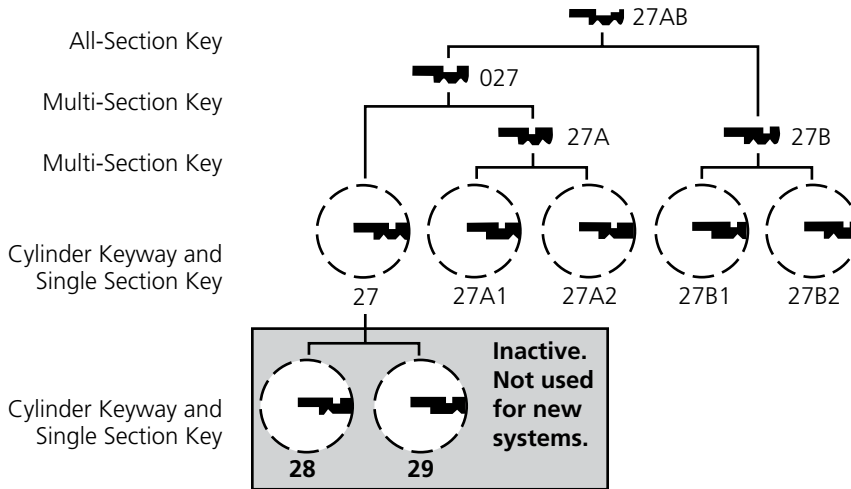

Security



Not Available

67 Series

7 keyways total (5 active).
Available 5-, 6- and 7-pin.
X Class bitting.
Reverse of 77 Series.

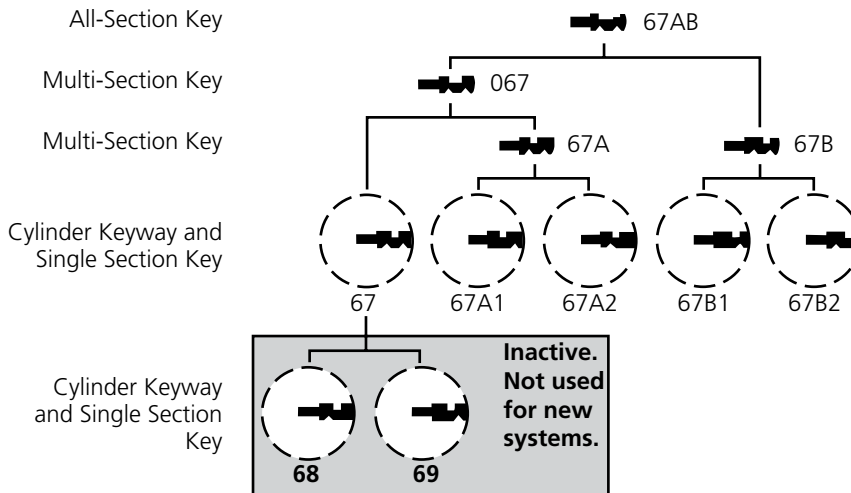

Security



Not Available

77 Series

7 keyways total (5 active).
Available 5-, 6- and 7-pin.
X Class bitting.
Reverse of 67 Series.

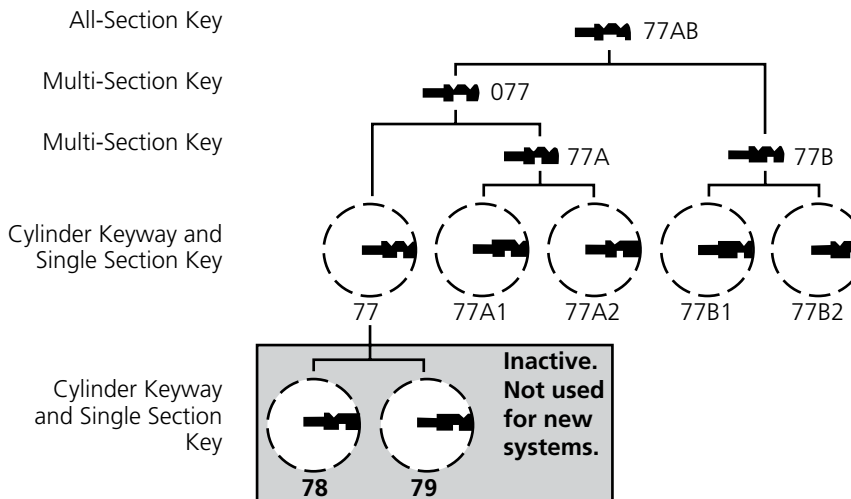

Security



Not Available

Keyways

Russwin® Inactive

Key Systems

981 Series

3 keyway multiplex system.
Available 5-, 6- and 7-pin.
981 Class bitting.

Security



Not Available

All-Section Key

Cylinder Keyway and
Single Section Key

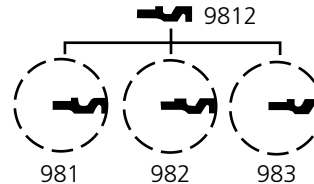

Former 6-pin Designations	961	962	963
Former 7-pin Designations	971	972	973

N Series (Obverse)

14 keyways total: N1- N14.
Available 5-, 6- and 7-pin.
N Class bitting.

Former Designations

6-pin: 1N-14N
5- and 7-pin: 1K-14K

Security



Not Available

All-Section Key

Multi-Section Key

Multi-Section Key

Cylinder Keyway and
Single Section Key

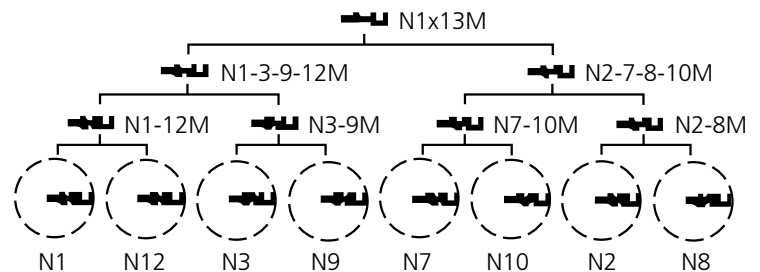

All-Section Key

Cylinder Keyway and
Single Section Key

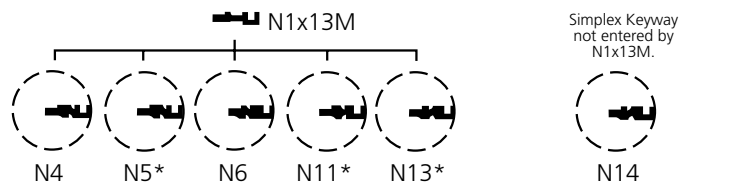

*NOTE: Do not use these pairs in the same keying system with each other: N1 with N13; N3 with N5; N7 with N11

N Series (Reverse)

14 keyways total: N15- N28.
Available 5-, 6- and 7-pin.
N Class bitting.

Former Designations

6-pin: 15N-28N
5- and 7-pin: 15K-28K

Security



Not Available

All-Section Key

Multi-Section Key

Multi-Section Key

Cylinder Keyway and
Single Section Key

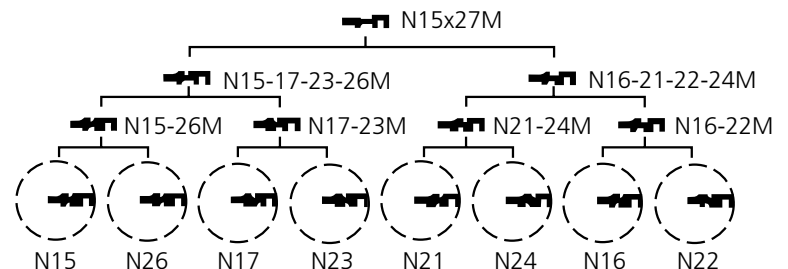

All-Section Key

Cylinder Keyway and
Single Section Key

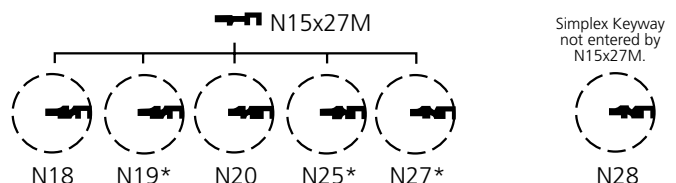

*NOTE: Do not use these pairs in the same keying system with each other: N15 with N27; N17 with N19; N21 with N25

Key Systems

852 Series

2 keyway multiplex system.
5-pin standard, 6-pin special.
Available with 10 Series
bows only.
No hotel function cylinders.

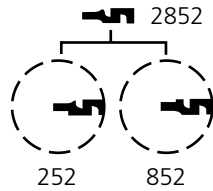

Simplex Keyways

5-pin only

752 uses 752 Class bitting
G uses 852 Class bitting
Available with 10 Series bows only.
No hotel function cylinders.

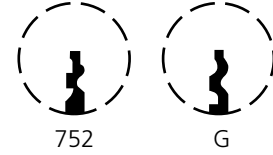

Security



Not Available

A Series (Obverse)

12 keyways: A1-A12.
5-pin standard, 6-pin special.
Available with 10 Series
bows only.
A Class bitting.
No hotel function cylinders.

All-Section Key

Multi-Section Key

Multi-Section Key

Cylinder Keyway and
Single Section Key

All-Section Key

Cylinder Keyway and
Single Section Key

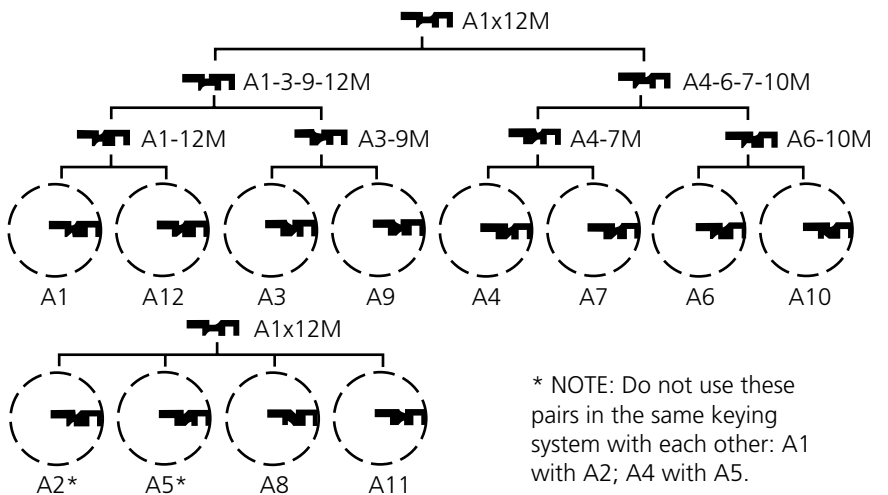

* NOTE: Do not use these
pairs in the same keying
system with each other: A1
with A2; A4 with A5.

Former Designations

5-pin: 1A-12A
6-pin: 1Z-12Z

Security



Not Available

A Series (Reverse)

12 keyways: A13-A24.
5-pin standard, 6-pin special.
Available with 10 Series
bows only.
A Class bitting.
No hotel function
cylinders.

Cylinder Keyway and
Single Section Key

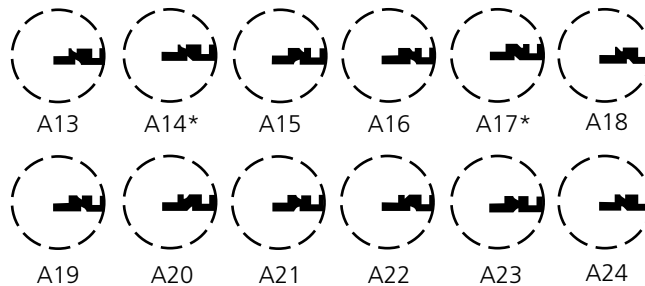

* NOTE: Do not use these pairs in the same
keying system with each other: A13 with A14;
A16 with A17.

Security



Not Available

Pyramid (Patented)

P3C Series

Keyway profiles not shown for security reasons.
4 keyway multiplex

Multi-Section Key
Cylinder Keyway and
Single Section Key

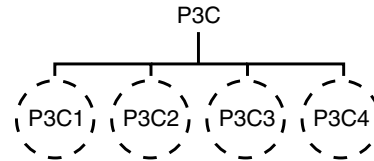

P3AB Series

Keyway profiles not shown for security reasons.
4 keyway multiplex

All-Section Key
Multi-Section Key
Cylinder Keyway and
Single Section Key

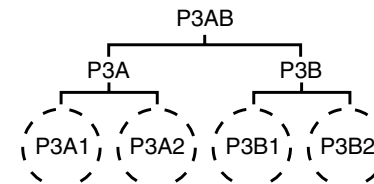

P4EF Series

Keyway profiles not shown for security reasons.
8 keyway multiplex

All-Section Key
Multi-Section Key
Cylinder Keyway and
Single Section Key

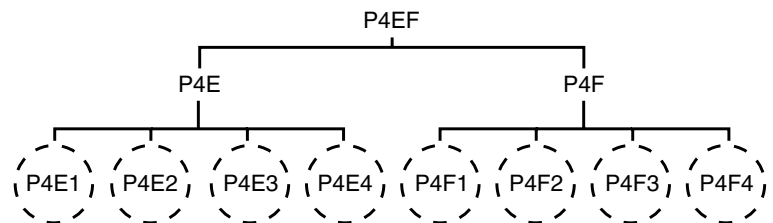

P4AD Series

Keyway profiles not shown for security reasons.
8 keyway multiplex

All-Section Key
Multi-Section Key
Multi-Section Key
Cylinder Keyway and
Single Section Key

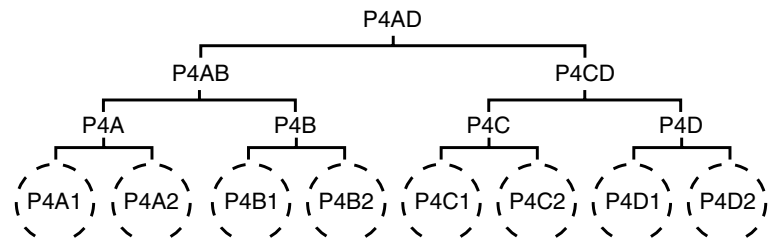

P5AD Series

Keyway profiles not shown for security reasons.
8 keyway multiplex

All-Section Key
Multi-Section Key
Multi-Section Key
Cylinder Keyway and
Single Section Key

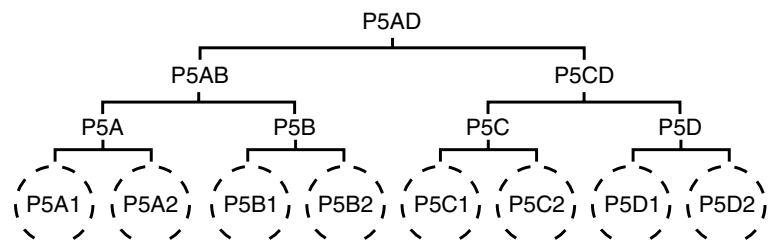

P6AD Series





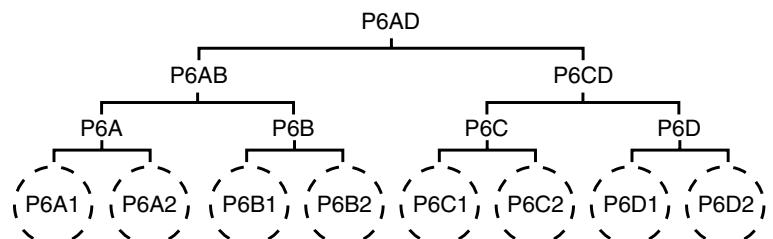



Keyway profiles not shown for security reasons.
8 keyway multiplex

All-Section Key
Multi-Section Key
Multi-Section Key
Cylinder Keyway and
Single Section Key



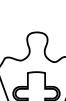

***Note:** Each P6 keyway will have its own unique side pin code locations to be assigned by Key Systems Administration. The side pin code is not available with the other Pyramid keyway families.

Cams for current products or models

Type	Part Number		Model/Description
	A01	Reg. 701F23 IC 701F23	Corbin Russwin Arrow®, Marks 5000, PDQ Steel case mortise locks except classroom and institutional privacy functions. Deadbolt functions of green cast iron case mortise locks. NOT for master ring mortise cylinders. All mortise functions using Cloverleaf cam.
	A02	Reg. 147F77 IC 334F13	Corbin Russwin Baldwin R. R. Brink Marks Steel case mortise lock classroom (55), inside of vestibule (42) and institutional privacy (69) functions. Most exit device trims. NOT for master ring mortise cylinders. All mortise locks. All except CKS. 7000, 9000 and most brands of older black cast iron locks.
	A03	Reg. 111F55 IC 362F42	Corbin Russwin Adams Rite® Lori DL3000 Series Cylindrical Deadlocks only. 1800 Series, 4015 Deadlocks; 4500 and 4700 Series Latch Locks. 4500, 4600 Series Deadlocks.
	A04	Reg. 413F22 IC 423F49	Corbin Russwin DL4000 Series Mortise Deadlocks only.
	A05	Reg. 105F70 IC 362F50	Adams Rite R. R. Brink 4070 Series Deadlocks. "CKS" Control Key Switch.
	A06	Reg. 626F07 IC 626F07	Schlage® L9000 Series (Cloverleaf only).
	A61	Reg. 562F40 IC 526F66	Corbin Russwin Best® Mortise Series deadbolt function master ring locks manufactured since June 10, 1993 (silver case). Adapt earlier (gold case) model to use this cam by installing thumbturn hub 562F41-2. H45 Series
	A62	Reg. 065F36	Corbin Russwin Corbin Russwin DORMA Mortise Series Master Ring classroom (55) function and inside of vestibule (42) function mortise locksets. 900 Series Mullion, WS700 Series Mullion (Both KRM) Mortise Locks
	A65	Reg. 025F72	Corbin Russwin Mortise Series: required for master ring deadbolt functions manufactured before June 10, 1993 (gold case) and for outside of current vestibule (42) function. Optional for current non-deadbolt functions except classroom (55) and inside of vestibule (42) function.
	A92	Reg. 266F34	Corbin Russwin Concealed vertical rod exit device outside grip handle operators 01 and 02.

Cams for obsolete Corbin Russwin products or models

	A63	121F01	Corbin Russwin Black cast iron case master ring mortise locks, except models with 1" throw deadbolt.
	A64	135F19	Corbin Russwin Black cast iron case master ring mortise locks with 1" throw deadbolt.
	A93	Reg. 281F27 IC 362F43	Corbin Russwin 610 and 1403 Series Cylindrical Deadlocks.

Cylinder Accessories

Collars and Master Ring Adapter

Key Systems

Standard Collars +

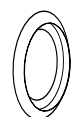
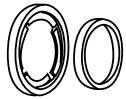

Spring	
253F97	.150" (5/32")
549F52	.219" (7/32") - Ring Only
605F43	.350" (11/32")
428F66	Packet: 549F52 + 253F97
Solid, Recessed for Cylinder Head	
447F41*	.031" (1/32"); total projection 1/4"
700F53	.090" (3/32") VR trim, double cylinder 1-1/4"
261F54	.094" (3/32") x 2-1/4" O.D. for ED6000 with T5, T6, T9, T9M, T10, T10M, T11M trim
270F15	.156" (5/32"); total projection 9/32"
598F89*	.156" (5/32"); total projection 9/32"
447F42*	.172" (11/64"); total projection 25/64"
610F01*	.221" (7/32"); total projection 7/16"
610F02*	.289" (9/32"); total projection 1/2"
654F07	.350" (11/32"); total projection 15/32"
447F43*	.375" (3/8"); total projection 19/32"
609F36*	.500" (1/2"); total projection 23/32"
134F05	.510" (1/2") for ED6800 x B5 or G6 and all ED7400, ED7800 with 1-1/8" cylinder
654F08	.550" (9/16"); total projection 11/16"
267F97	.635" (5/8") for ED6800 x O1 or O2 with 1-1/8" and ED6800 x B5 or G6 and all ED7400, ED7800 with 1-1/4" cylinder
609F37*	.650" (21/32"); total projection 7/8"
399F48	.749" (3/4") for ED6800 x O1 or O2 with 1-1/4" cylinder
609F38*	.850" (27/32"); total projection 1-1/16"
Spacers for Flexible Head Cylinders	
370F29	.125" (1/8")
370F31	.250" (1/4")
252F82	.315" (5/16")
Other Solid Collars	
416F39*	.172" (11/64") security collar; total projection 13/32"
303F25	.312" (5/16") for 1-1/8" cylinder on aluminum door
Miscellaneous	
255F53	Rim cylinder, flush mount
422F88	Rim cylinder, surface mount
197F34	Wave washer



Master Ring Collars +

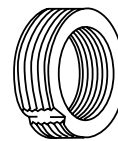

Solid, Recessed for Cylinder Head	
447F44*	.031" (1/32"); total projection 1/4"
261F55	.094" (3/32") X 2-1/4" O.D. for ED6000 with T5, T6, T9, T9M, T10, T10M, T11M trim
447F45*	.172" (11/64"); total projection 25/64"
447F46*	.375" (3/8"); total projection 19/32"
Spacers for Flexible Head Cylinders	
366F70	.090" (3/32") tapered
370F33	.094" (3/32")
370F35	.281" (9/32")
Miscellaneous	
255F54	Rim cylinder, flush mount
197F35	Wave washer

Master Ring Adapter

For installing standard diameter mortise cylinder in master ring lockset. Specify 522F93-2. Order cam separately. See page 40.

* Number includes wave washer in packet
+ Refer to corresponding parts and service manuals for correct cylinder collar applications and selection guide

Key Systems

Collars

- 1-3/4" (44mm) thick door. For other door thicknesses and trim considerations, contact Corbin Russwin Technical Product Support.
- Mortise Cylinders – 1-1/4" (32mm) length

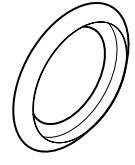
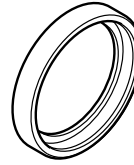

	Spring 605F43 (.350)	447F41 (.030)	700F53 (.090)	270F15 (.156)	598F89 (.156)	Solid 447F42 (.172)	610F02 (.289)	447F43 (.375)	654F07 (.350)	267F97 (.635)	Surface Mount 422F88 (.000)
Mortise Cylinder											
High Security Separately (1020, 1030)							X				
Security Separately (1027, 1037)	X										
Mortise Lock											
<i>Single Cylinder</i>											
Sectional							X				
N Escutcheon					X						
P Escutcheon					X						
M Escutcheon					X						
L & R Escutcheon		X									
T Escutcheon (no collar required)											
<i>Double Cylinder</i>											
Sectional								X			
N Escutcheon							X				
P Escutcheon							X				
M Escutcheon							X				
L & R Escutcheon						X					
T Escutcheon						X					
V Escutcheon			X								
Auxiliary Locks											
DL4011, 4013, 4017						X					
DL4012								X			
Rim Cylinder											
High Security Separately (3020, 3030)											X
Security Separately (3027, 3037)											X
Exit Devices											
<i>ED4000-5000 Series</i>											
700 Trim, F2, F3, T13, P9									X		
K1				X							
700M Trim, F2M, F3M, T13M							X				
900 Trim											X
Cylinder Dogging				X							
<i>ED6000 Series</i>											
N3, G4, T3				X							
N4M, G5M											X
T7M, T9M					X						
<i>ED7000 Series</i>											
P4, P6, P7		X									
C4, O3, O5										X	
T11				X							
<i>ED8000 Series</i>											
KO											X
F1, P1, P2 (no collar required)											

Plug Diameters/Quick Codes

Key Systems

Corbin Russwin Cylinder Plug Diameters

When combining Corbin Russwin cylinders, the diameter of the plug determines the set of bottom pin and build-up pin lengths to use. The plug diameter is either .509" or .552". All Pyramid cylinders have a plug diameter of .496" and have their own pin kit. Current Corbin Russwin cylinder plug diameters are listed below by product series. Before 1983, however, all Corbin® X Class cylinders used .509" diameter plugs.

Product Series	Security Bolt	Plug Diameter	Product Series	Cylinder Type	Plug Diameter
CL3200 Series	Security Bolt	.509"	1400/4300 Series (obsolete)	Cylindrical	.552"
CL3300 CL3500, CL3800 Series	Cylindrical	.509"	Pyramid Series	All	.496"
CL3400 & CL3600 Series	Cylindrical	.509"			
CL3700 Series	Cylindrical	.509"	Mortise Cylinders		.552"
CL3900 Series	Cylindrical	.509"	Rim Cylinders		.552"
CK4200 CL3500, CL3800 Series	Cylindrical	.552"	Interchangeable Cores		.509"
CK4400 Series	Cylindrical	.509"	Padlocks		.509"
CK4700 Series	Cylindrical	.509"	Competitors' Key-in-Lever/Knob		.552"
UT5200 Series	Unit Lock	.552"	Security, all cylinders		.552"
DL2100 Series	Deadlock	.509"	Exit Devices, except IC		.552"
DL3000 Series	Deadlock	.552"	A6/N6/PR6 trim and obsolete		.509"
DL3100 Series	Deadlock	.509"	NS/AS trim		.509"

Cylinder Options

Description	Quick Code
IC 6-pin with temporary construction core	CT6
IC 6-pin with temporary construction core (Red)	CT6R
IC 6-pin with temporary construction core (Blue)	CT6B
IC 6-pin with temporary construction core (Green)	CT6G
IC 6-pin with disposable temporary core	CT6D
IC 6-pin with SFIC disposable temporary core ¹ (Mortise)	CT6SD ¹
IC 6-pin with small format temporary disposable core	CTSD
IC 7-pin with temporary construction core	CT7
IC 7-pin with temporary construction core (Red)	CT7R
IC 7-pin with temporary construction core (Blue)	CT7B
IC 7-pin with temporary construction core (Green)	CT7G
IC 7-pin with disposable temporary core	CT7D
IC 7-pin with SFIC disposable temporary core ¹ (Mortise)	CT7SD ¹
Pyramid with temporary construction core	CTP
Pyramid with disposable temporary core	CTPD
SFIC 6-pin with less core (rim and mortise)	CLS6
SFIC 7-pin with less core (rim and mortise)	CLS7
Bump-resistant cylinders	BRP

Keying Options

Description	Quick Code
0-bitted with 2 blank keys (except HS, CHS)	(standard)
Keyed random	KR
Keyed alike	KA
Keyed to specific bitting (specify bitting)	KS
Uncombined	UC
Construction master keyed	CMK

Key Quantity Options

2 change keys per cylinder ²	(standard) ²
Other than 2 change keys per cylinder (i.e. customer requests 6 change keys per cylinder)	KY# (i.e., KY6)
No change keys	KY0
Master keys (if required) ³	Specify Qty.
Control keys (if required) ³	Specify Qty.
CMK keys (if required) ³	Specify Qty.
CMK control keys (if required) ³	Specify Qty.
SKD control keys (if required) ³	Specify Qty.
Special purpose keys, i.e., ENG (if required) ³	Specify Qty.

¹Corbin Russwin does not furnish permanent SFIC cores

²Keys shipped separately for security and Pyramid master keyed cylinders

³Order as cut keys

Collar Options - Mortise and Rim Cylinders Only

Description	Quick Code
Collar packet (549F52 + 253F97)	428F66
Rim collar, flush mount	255F53
Rim collar, flush mount (master ring)	255F54
Rim collar, surface mount (standard for rim cylinders)	422F88
Solid collar - .030	447F41
Solid collar - .031 (master ring)	447F44
Solid collar - .090 (VR trim only)	700F53
Solid collar - .094	261F54
Solid collar - .094 (master ring)	261F55
Solid collar - .156	270F15
Solid collar - .156	598F89
Solid collar - .172 (tapered security collar)	416F39
Solid collar - .172	447F42
Solid collar - .172 (master ring- standard for MR 118 cylinders)	447F45
Solid collar - .221	610F01
Solid collar - .289	610F02
Solid collar - .312	303F25
Solid collar - .350	654F07
Solid collar - .375	447F43
Solid collar - .375 (master ring)	447F46
Solid collar - .500	609F36
Solid collar - .510	134F05
Solid collar - .550	654F08
Solid collar - .635	267F97
Solid collar - .650	609F37
Solid collar - .749	399F47
Solid collar - .850	609F38
Spacer for flexible head cylinders - .125	370F29
Spacer for flexible head cylinders - .250	370F31
Spacer for flexible head cylinders - .315	252F82
Spacer for flexible head master ring cylinders - .094	370F33
Spacer for flexible head master ring cylinders - .281	370F35
Spacer for flexible head master ring cylinders (tapered) - .090	366F70
Spring collar - .150 (standard for 118 cylinders)	253F97
Spring collar - .219	549F52
Spring collar - .350 (standard for 114 cylinders)	605F43

Quick Codes/How to Order

Key Systems

Stamping Options*

Description	Quick Code
Keys stamped with bitting number	(standard)
No keyset or bitting stamping on keys	VKC0
Keys only stamped with keyset (standard for HS, CHS, PS, PHS, PCS, PCHS)	VKC1
Keys stamped with keyset, cylinders stamped with keyset on face of plug - not available for HS, CHS, PS, PHS, PCS, PCHS	VKC2
Keys stamped with bitting, cylinders stamped with keyset on face of plug - not available for HS, CHS, PS, PHS, PCS, PCHS	VKC3
Keys stamped with keyset, cylinders stamped with keyset in concealed location	CKC2
Keys stamped with bitting, cylinders stamped with keyset in concealed location- not available for HS, CHS, PS, PHS, PCS, PCHS	CKC3
Less Trade Mark (No Corbin Russwin logo on cylinders)	LTM

*see page 6 for detailed descriptions

KeyBow Options

Description	Quick Code
Corbin Russwin logo	(standard)
Plain both sides	KB11
Do Not Duplicate	KB12
US Property Do Not Duplicate	KB13
Patented Do Not Duplicate (only for patented keyways)	KB18
Restricted Do Not Duplicate (only for restricted keyways)	KB19
Pyramid (only for Pyramid keys)	KB28
Large bow, plain both sides	KB51
Large bow, Do Not Duplicate	KB52
Large bow, US Property Do Not Duplicate	KB53
Large bow, Patented Do Not Duplicate (only for patented keyways)	KB58
Large bow, Restricted Do Not Duplicate (only for restricted keyways)	KB59
Security bow Corbin Russwin logo (only for security keys)	KB90
Security bow plain both sides (only for security keys)	KB91
Security bow, Do Not Duplicate (only for security keys)	KB92
Security bow, US Property Do Not Duplicate (only for security keys)	KB93
Security bow, Patented Do Not Duplicate (only for security keys, patented keyways)	KB98
Security bow, Restricted Do Not Duplicate (only for security, restricted keyways)	KB99

How to Order Cylinders

Mortise Separately

Keyset	Cylinder	Length	Cam	Pins	Keyway	Finish
AA1	1000	118	A01	7	L4	626

Rim Separately

Keyset	Cylinder	Length	Pins	Keyway	Finish
AA1	3000	058	7	L4	626

Key-in-Lever/Knob Separately

Keyset	Cylinder	Lockset Series	Pins	Keyway	Finish
AA1	2000	033	7	L4	626

IC Cores Separately

Keyset	Cylinder	Pins	Keyway	Finish
AA1	8000	7	L4	626

Key Systems

Single System Pin Kits

For the end user with one Corbin Russwin System 70 keying system to maintain. Each kit has all pins necessary to combine interchangeable core and master ring cylinders, as well as conventional cylinders (both .509" and .552" plug diameters). Furnished in a handsomely finished hardwood case with combining instructions on the inside of the lid. Includes key gauge, tweezers and both diameter plug followers.

PK-70-ZDH

For pinning all types of cylinders (except security) with Z Class keyways: 59, D, H and L Series, plus 60, 70 and restricted/patented keyways using System 70 depths (1-6).

PK-70-X

For pinning all types of cylinders with X Class keyways: 27, 57, 67 and 77 Series, plus AR, BR, BL, 97 and 99 using System 70 depths (1-6).

PK-70-N

For pinning all types of cylinders with N Class keyways: N1-N28 using System 70 depths (1-6).

Security Pin Kit

PK-70-HS

For security cylinders, including interchangeable core, Brink and blockout function. Furnished in a handsomely finished hardwood case with combining instructions on the inside of the lid. Includes tweezers.

Deluxe Pin Kit

PK-1070

Ideal for locksmiths and distributor service personnel who must service a variety of Corbin Russwin keying systems. Also for end users with Pre-System 70 keying systems.

Contains all pins required to combine standard, IC and master ring cylinders. Accommodates System 70 and non-System 70 for both plug diameters and all key classes. Furnished in a reinforced steel case with combining instructions on the inside of the lid. A separate, removable, two-sided chart contains pin lengths for all modern key classes. Includes tweezers and both diameter plug followers.

PK-20-HS

Each pin kit has all the pins necessary to combine standard and interchangeable core Pyramid High Security cylinders. Includes tweezers, plug follower, key gauge and combining instructions.

PK-20-PS

Each pin kit has all the pins necessary to combine standard and interchangeable core Pyramid Security Cylinders. Includes tweezers, plug follower, key gauge and combining instructions.

Pyramid Sample Display Case

S-20-DC

Contains sample Master Keyed Cylinders and information materials.



PK-70-ZDH
PK-70-X
PK-70-N



PK-70-HS

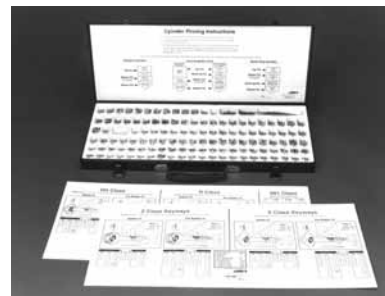

PK-1070

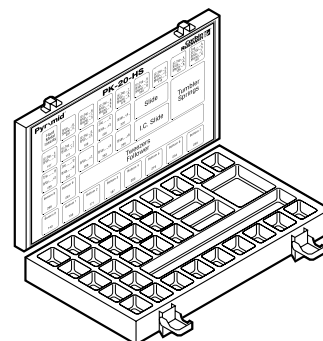

PK-20-HS

Key Systems

For a complete listing of all Cylinder Components, refer to Cylinder/Owner's Manuals.

How to Order Conventional Pins

Suffix 3-digit length in thousandths of an inch to base number.
Example: .160" bottom pin is 553F484-160.

Description	Number
Specify quantity of vials (100 pins/vial):	
Bottom Pins (L Series)	553F48-4 + length
Master/Top/Build-up Pins (M Series)	553F49-2 + length
Specify quantity of vials (1500 balls/vial):	
Construction Balls	546F97-8
<ul style="list-style-type: none"> • Pins are packaged in a secure, spill-proof plastic vial with hinged top. • 12 vials per master carton. 	

How to Order Security Pins

Replace the "x" in the part number with the pin's skew number.
Bottom pins use skews **L** (1) and **R** (2).
Master pins use skews **L** (1), **R** (2) and **S** (3).
Example: #2 master pin with S skew is 407T334-097.

Description	Number
Specify quantity of pins (must be multiple of 20):	
Bottom Pin, #2	407T4x4-242
Bottom Pin, #3	407T4x4-270
Bottom Pin, #4	407T4x4-298
Bottom Pin, #5	407T4x4-326
Bottom Pin, #6	407T4x4-354
Master Pin, #2	407T3x4-097
Master Pin, #3	407T3x4-125
Master Pin, #4	407T3x4-153
Top Pin #1 (long)	407T43-4193
Top Pin #2 (short)	407T43-4158

How to Order Pyramid Security Pins

Suffix 3-digit length in thousandths of an inch to base number.

Description	Number
Specify quantity of vials (100 pins/vial):	
Bottom Pins (Nickel Silver)	695F244 + length
Master/Build-up Pins/Top (Brass)	695F252 + length

How to Order Pyramid High Security Pins

Suffix 3-digit length in thousandths of an inch to base number.

Description	Number
Specify quantity of vials (100 pins/vial):	
Bottom Pins (Stainless Steel)	695F247 + length
Master/Build-up Pins/Top (Stainless Steel)	695F257 + length

How to Order Pyramid Bump Resistant Pins

Description	Number
Specify quantity of vials (100 pins/vial):	
Size A	628F107142
Size C	628F107236

How to Order Pyramid P6 Side Pins

Description	Number
Specify quantity of vials (20 pins/vial):	
P6 Side Pin	630F494

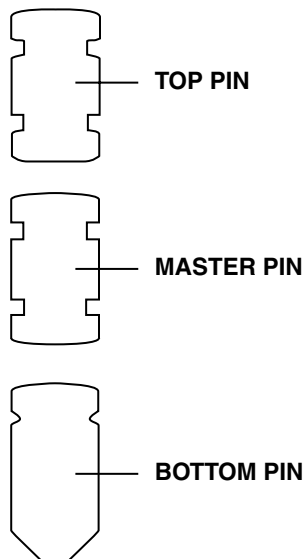
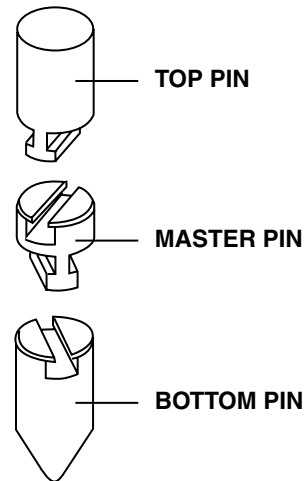
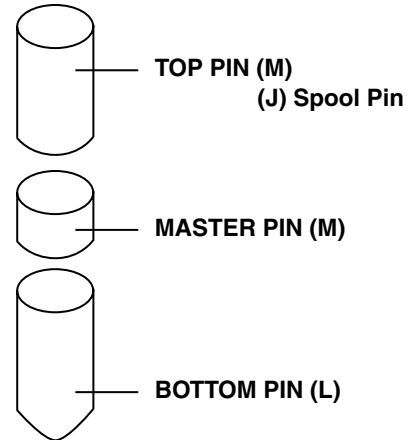

Cylinder Tool Kit No. CT-93

Kit No. CT-93 contains the following items (also available separately):

CT-4	Follower for 509" diameter plugs
CT-11	Key gauge for Corbin® X and Z Class System 70 and pre-System 70
CT-19	Tweezers
CT-21	Key gauge for Russwin® N Class System 70 and pre-System 70
CT-22	Key gauge for Russwin DH Class System 70 and pre-System 70
CT-23	Key gauge for Russwin 981 and 852 Classes
CT-26	Waldes Tru-Arc pliers (see below for full description)
CT-54	Follower for .552" diameter plugs

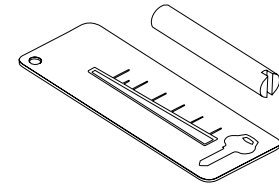

Pyramid Tools

CT-20	Pyramid plug follower (.495" diameter)
CT-20K	Key Gauge for Pyramid

Other Tools

CT-5	Pin Chamber Reamer
CT-7	Pin Chamber Burring Tool
CT-10	Loading tool for CK4400 Series and IC cylinder shells

Cylinder Installation Wrench No. CT-80

CT-80 is for interchangeable core mortise cylinders. It is used to:

- Install and remove Corbin Russwin interchangeable core mortise cylinder housing without marring cylinder scalp finish.
- Test cam operation before fastening the mortise cylinder set screw.
- Align the pins of the throw member before installing the core.

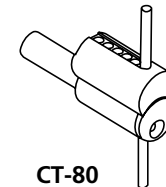

CT-80

Waldes Tru-Arc Pliers

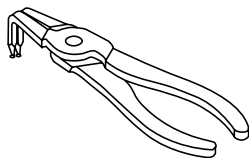

No. CT-25

When rekeying or exchanging cylinders in CK4200 and UT5200 Series knobs, this tool is used to remove the large knob shank retaining ring to gain access to the cylinder.

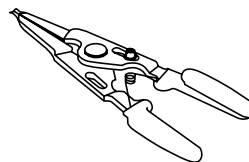

No. CT-26

When rekeying CK4200 and UT5200 Series cylinders, this tool is used to remove the plug retainer.

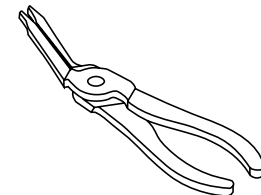

No. CT-27

When rekeying or exchanging cylinders in UT5200 Series Unit Lock lever handles, this tool removes and installs the cylinder retaining ring.

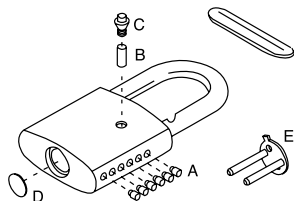
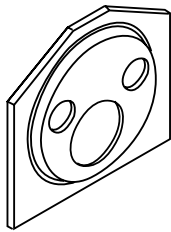
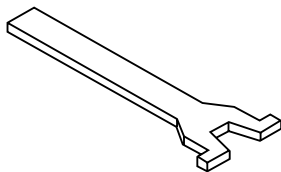
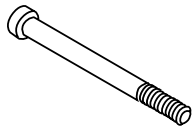

Screws	
438F41 -8	Cam screw, mortise cylinder
438F42-8	Cam screw, IC mortise cylinder
488F08-8	Mortise cylinder set screw packet (1 screw), standard cylinder size
488F10-8	Mortise cylinder set screw packet (1 screw), master ring
021F68-8	Rim cylinder mounting screw, 2-9/32" long for 1-3/8" - 2-1/2" doors
021F71-8	Rim cylinder mounting screw, 3-1/8" long for 2-3/4" - 3-1/2" doors
Disposable Core 10 Packs	
627F00-9	Corbin Russwin LFIC
707F21-9	Corbin Russwin SFIC
Tailpieces	
655F00-8	5/8" horizontal for rim cylinder 3000-058
655F01-8	5/8" horizontal for IC rim cylinder 3080-058
582F29-8	1-1/4" horizontal for IC rim cylinder 3080-114
490F55-8	1-3/8" horizontal for rim cylinder 3000-138
253F85-8	1-7/8" horizontal for IC rim cylinder 3080-178
483F09-8	1-7/8" vertical for IC rim cylinder 3080-178V
253F76-8	2" horizontal for rim cylinder 3000-200
413F48-8	2" vertical for rim cylinder 3000-200V
284F13-8	3-1/8" horizontal for IC rim cylinder 3080-318
253F77-8	3-1/2" horizontal for rim cylinder 3000-312
413F49-8	3-1/2" vertical for rim cylinder 3000-312V
622F30-8	For 2000-033 & 2000-034-7 cylinders
622F29-8	For 2000-034-6 cylinder
682F29-8	For 2000-037 & 2000-033-7 cylinders
596F89-8	For 2000-038 cylinder
489F02-8	For 2000-051 cylinder
680F60-8	For 2000-039 cylinder
681F60-8	For 2000-039L cylinder
Rim Cylinder Back Plates	
253F75-8	For standard and Pyramid rim cylinders
135F10-8	For master ring rim cylinders
Retainers	
173F79-8	.020" thick for 2001 -051 cylinder
368F91-8	.030" thick for rim, 2200, 2210 & 3000 Series cylinders
488F92-8	.032" thick for CK4200 and 1400/4300 Series locks
333F99-7	For CK4400 Series Locks, 4300 Series Cylinders, 8000 cores and Pyramid
655F41-5	For 3080 IC rim cylinder
680F64-5	Threaded cap for 2000-033, 034, 037, 039, Security & Pyramid KIL cylinders
585F31-2	Cap pin for above
Springs (Ordered in multiples of 100)	
585F32-7	For 2000-033, 034, 037, 039, Security & Pyramid KIL cap pin)
172F21-7	IC Conventional & Security
603F20-7	Fixed Core Conventional & Security
026F75-7	Hotel Mortise blocking pin
697F50-7	All Pyramid Cylinders
314F98-7	For 2001-034 indicator
Spring Covers	
217F42-2	5-pin brass (Rim/Mortise/IC)
217F44-2	6-pin brass (Rim/Mortise/IC/Pyramid IC)
314F88-7	6-pin stainless (2000 Series Knob/Lever)
217F43-2	7-pin brass (Rim/Mortise/IC/Pyramid Rim & Mortise)
585F39-7	7-pin stainless (2000 Series Lever/Pyramid KIL/KIK)
411F092	Pyramid KIL/KIK for other manufacturers products (2200 Series)
Padlock Parts	
303F24-2	Pin chamber cap (A)
232F03-7	Plug retainer (B)
242F48-2	Plug retainer screw (C)
405F77-2	Security disc (D)
362F15-3	Throw member for IC model (E)

Policies and Procedures

Key Systems

Procedures

Corbin Russwin keying systems utilize the Standard Key Coding System illustrated on the following pages. To ensure prompt and accurate processing, purchase orders should be written using these key symbols to describe each master keyed item. In addition to the key symbol, Corbin Russwin requires the following information on the keying system for ALL orders:

- End User (job) Name
- City, State, Zip Code
- Special key bows or key stamping
- VKC/CKC requirements (see page 6)

New Systems or New Branches of Existing Systems

Indicate system expansion in terms of estimated numbers of key combinations, not doors. All of this information is essential at the inception of a keying system in order for Corbin Russwin to ensure accommodation of the end user's present and future needs. Advise as follows:

- How many levels of keying?
- Plan for a construction master key?
- Any selective master keys, such as ENG?
- How many changes for each master?
- How many masters for each grand master? If mixing Corbin Russwin cylinder types, indicate clearly where each type of cylinder will be used within the expansion parameters:
 - Which masters or grands have security cylinders under them?
 - Which have interchangeable cores?
 - Which have master ring?
 - Which have conventional cylinders?

Existing System Add-Ons

For prompt processing, orders must include a positive identification for the keying system in addition to the job name, city, state and zip code. Any ONE of the following is positive ID:

- Registry number stamped on any existing factory master key
- Previous factory order number together with the year of that order

Letters of Authorization

No letter is needed when the items are to be drop shipped directly to the end user. In all other cases, to preserve the security of the end user's keying system, Corbin Russwin requires a letter of authorization on the end user's letterhead to obtain the following:

- Bitting lists
- Security blanks and cut keys
- Master level cut keys
- Patented key blanks, cylinders and plugs
- Pyramid key blanks, cylinders, and plugs

The letter of authorization can be brief but should include a specific description of what is being authorized for release, and a positive key system identification.

Pyramid Key Discard Policy

U.S. Utility Patent number 6,125,674 protects Pyramid keys from unauthorized duplication until the year 2018.

It is essential that cut keys and key blank distribution policies and procedures be maintained and enforced for all Pyramid products.

Authorized Pyramid Distributors

Pyramid is a system-based product. An authorized distributor can stock Pyramid upon specific written authorization from the primary systems administrator of the facility. Authorized distributors have the ability to receive product, key product, cut keys and distribute the product to the facility.

Authorized Pyramid distributors who carry inventory for a specific system must provide valid receipts and disbursements of all Pyramid products, specifically key blanks/cut keys. All Pyramid key blanks to be maintained in the possession of an authorized Pyramid distributor must be accounted for. Any defective, incorrectly cut or damaged Pyramid key blanks must be retained in the distributor's possession to be reviewed and collected by a representative of ASSA ABLOY Door Security Solutions.

XYZ Corporation

1 Main St.
Anytown, USA 00001
(203) 555-5555

(Current Date)

Corbin Russwin Architectural Hardware
Key Systems Dept.

We authorize Acme Distributors to obtain a copy of the bitting list for our keying system GGMX5555. We also authorize them to order the quantities of master keys on our attached purchase order 1234AB.

Sincerely,

Gordon Morris
Security Director

Pyramid Primary System Administrators

Any defective, incorrectly cut or damaged Pyramid key blank must be destroyed.

Pyramid Key Warranty

Pyramid key blanks are covered by a 5-year warranty as outlined in the current list price book.

Pyramid Registration Certificates

For each Pyramid system established the designated owner's representative will receive a Pyramid Owner's binder containing registration certificates specific to their system. Registration certificates will contain the facility registration number along with the facility name and location and must be signed by an authorized representative for the facility. Each order submitted for Pyramid product must be accompanied by a registration certificate. Additional certificates will be obtainable through Key Systems Administration.

	Facility Registration	System Registry + Zip Code + Certificate Number
Facility Name _____		
Address #1 _____		
Address #2 _____		
City _____ State _____ Zip _____		
Authorized Representative _____		
Print		
Distributor _____ PO# _____		

Key Systems

To Specify a Simple Master Key System (2 Levels of Keying)

The master key symbol consists of TWO letters, such as **AA**. The change key numbers are added to the master key letters. The numbers come FIRST: **1AA**, **2AA**, **3AA**, etc.

When locks are required which are not operated by the master key or other change keys in the system, they are referred to as "single keyed" and given symbols **SKD1**, **SKD2**, etc. When all higher levels of master keys are to be disallowed, suffix (**NMK**) to the symbol of the key which is to operate. This means

"not master keyed." Cylinder **1AA(NMK)** is operated by **1AA** only. The **AA** master is blocked from operation.

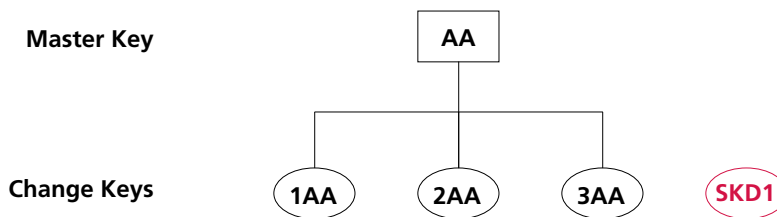

To Specify a Grand Master Key System (3 Levels of Keying)

The grand master is assigned any ONE letter, such as **A**. The master keys under this grand are assigned TWO letters, the first of which must be the same as the grand: **AA**, **AB**, **AC**, etc. are all masters under grand **A**. Masters **BA**, **BB**, **BC**, etc., are all under grand **B**. Caution: Do not use the letters **I**, **O** or **Q** because of possible confusion with the numerals 1 and 0, respectively. Also do not use the letter **X** due to confusion with cross keying. Change key numbers come after the letters.

For master keys beyond **AZ**, insert a numeral between the letters to designate which pass through the alphabet they represent. **A2A** through **A2Z** represents the second pass of masters under grand **A**. **A3A** through **A3Z** would be the third. Change keys under these masters have the numbers suffixed in the usual way: **A2A1**, **A2A50**, etc.

When locks are required which are not operated by ANY master keys or other change keys in the system, they are referred to as "single keyed" and given symbols **SKD1**, **SKD2**, etc.

If the cylinder is to be operated by its change key and nothing lower than the single lettered GMK, the change number is added to the GMK symbol. This is illustrated by the example **A1** in the schematic shown.

When all higher levels of master keys are to be disallowed, suffix (**NMK**) to the symbol of the key which is to operate. This means "not master keyed" and can be applied to any level in the system. Cylinder **AA1 (NMK)** is operated by **AA1** only. The **AA** master and **A** grand are blocked from operation. Cylinder **AA (NMK)** would be operated by the **AA** master only. Grand **A** does not operate.

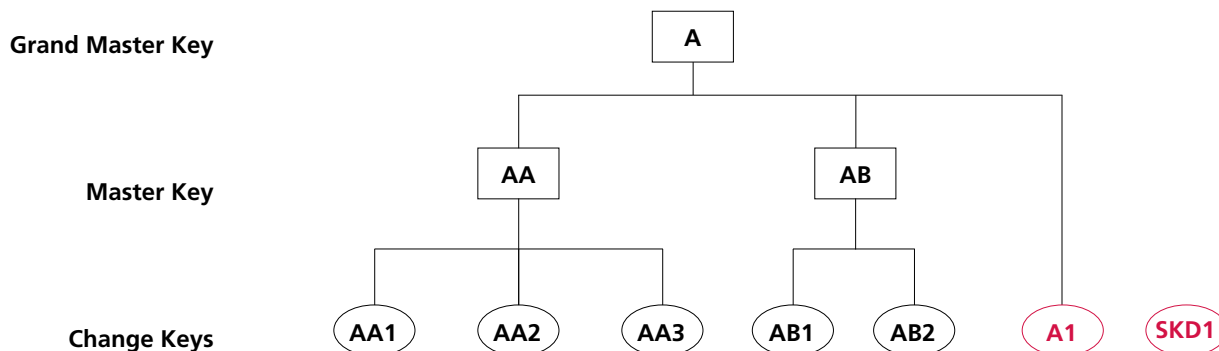

How to Establish Key Systems

4-Level Systems

Key Systems

To Specify a Great Grand Master Key System (4 Levels of Keying)

The great grand master key is assigned the symbol **GGM**. The rest of the symbols are the same as those in 3-level systems: The GMKs are assigned single letters, e.g., **A, B, C, D**, etc. Caution: Never use **X** for a grand master key due to the confusion which will result with cross keying symbols presented on page 52.

Masters under each GMK are assigned two letters, the first of which is the same as its respective grand master key. Change key numbers come *after* the letters. Changes

under the grand (**A1, B1**, etc.) and masters beyond **AZ** are handled exactly as in the 3-level system already described.

Changes directly under a grand are also handled as illustrated in the 3-level system. For changes directly under the **GGM** with no intermediate level masters, the change number is added directly to **GGM** as shown by the example **GGM1** in the schematic.

When locks are required which are not operated by ANY master keys or other change keys in the system, they are referred to as "single keyed" and given

symbols **SKD1, SKD2**, etc.

When all higher levels of master keys are to be disallowed, suffix (**NMK**) to the symbol of the key which is to operate. This means "not master keyed" and can be applied to any level in the system. Cylinder **AA1 (NMK)** is operated by **AA1** only. The **AA** master, **A** grand and **GGM** are all blocked from operation. Cylinder **AA (NMK)** is operated by the **AA** master only. Grand **A** and the **GGM** do not operate. Cylinder **A (NMK)** would be operated by the **A** grand only, without the **GGM**.

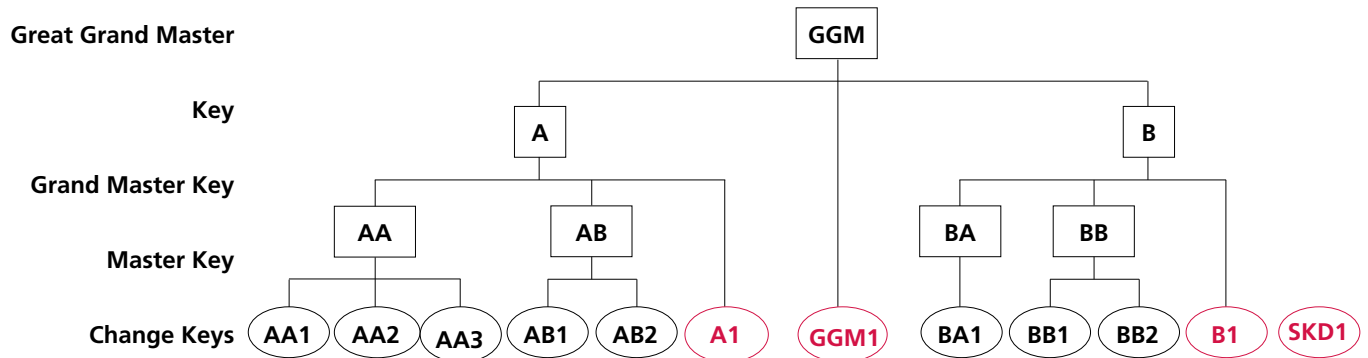

Selective Master Keys

It is often useful in large keying systems to issue a high level master key to maintenance personnel which allows access across all master and grand master key boundaries of a keying system. A selective master key is usually very close to the system's top master key, both physically and through its realm of access. Nevertheless, it must be blocked from operating in many areas.

The most common names and symbols for selective master keys are:

- ENG Engineer's key
- ATT Attendant's key
- JAN Janitor's key
- HKP Housekeeper's key
- GRD Guard's key
- MAIN Maintenance

To designate that a lock be operated by a selective master key, suffix the symbol in parentheses to the standard symbol. Example: **AA1 (ENG)**. This must be added *every time* the selective key is to operate and left off whenever the selective key is NOT to operate. For instance, you may lay out a system in which key **AA1** is to operate two different offices. Inside one of them is an electrical cabinet which must be accessible to maintenance personnel carrying the **ENG**

key. That lock must be specified as **AA1 (ENG)** while the lock for the other office must be specified as **AA1**. Change keys directly under the selective key, such as **ENG1**, are operated by all higher level keys, such as **GGM**.

Like cross keying, a selective master key is a convenience feature which decreases the security of the cylinders it operates and limits the expansion and flexibility of the overall keying system.

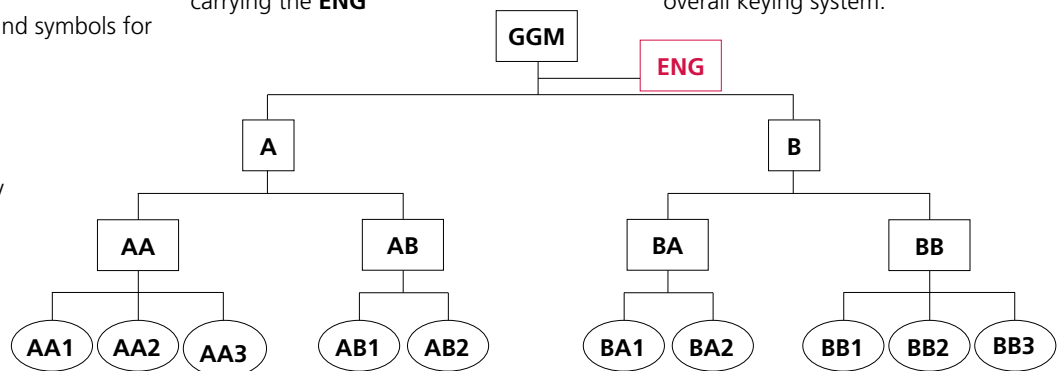

How to Establish Key Systems

Key Systems

Convenience May Reduce Cylinder Security and Hinder System Expansion

Whenever two or more different keys such as **AA1** and **AA2** are both required to operate the same cylinder, the cylinder's security is reduced. This is called *cross keying*. When the cross keying occurs under all the same higher level keys, such as **AA1** and **AA2**, it is known as *controlled cross keying*. When it combines keys under different higher level keys, such as **AA1** and **AB1**, it is known as *uncontrolled cross keying*.

In addition to reducing the security of the cylinder, cross keying usually imposes limits on the flexibility and expansion of the overall keying system. This is especially true of uncontrolled cross keying. For these reasons, it is strongly recommended to allow personnel to carry more than one key. Cross keying should be discouraged whenever possible. However, when cross keying is required, it is specified as follows, and should be summarized at the beginning of each order.

Case #1

Cylinder requires its own change key. The illustration depicts part of a small medical building where two doctors share a common receptionist. The receptionist gets the **AA3** key. Each doctor carries a key which operates only one office, but is also cross keyed into the entrance from the corridor.

Determine the symbol of the change key (example: **AA3**). Then prefix the letter X (example: **XAA3**). Then list all keys which are to operate in an "operated by . . ." phrase. Example: "**XAA3** operated by **AA1**, **AA2**, **AA** and **A**". Note that **X** is a cylinder specification only. The keys for cylinder **XAA3** are designated **AA3**.

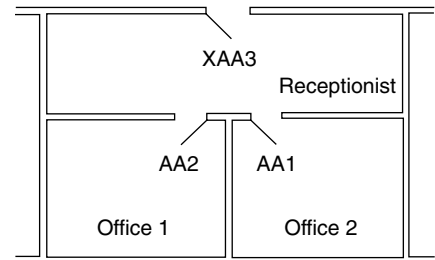

XAA3 operated by AA1, AA2, AA and A.

Case #2

Cylinder does NOT require its own change key. This illustration depicts a section of a floor in a dormitory. Each student's bedroom key operates the hall door lock. There is no need to construct a key which operates only the hall door.

In this case, place an **X** at both the beginning and end of the symbol and a number between them. Example: **X1X**, **X2X**, etc. Again, *always include the "operated by . . ." phrase with a complete listing of key symbols to operate.*

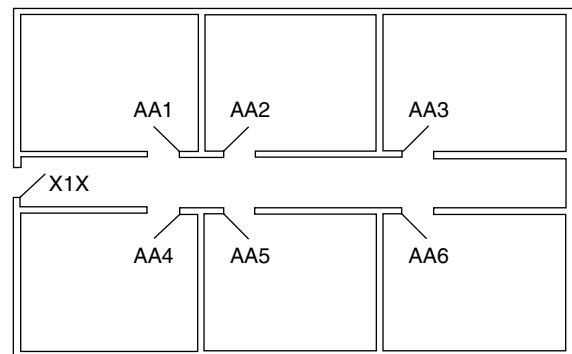

X1X operated by AA1 through AA6, AA and A.

Notes

Key Systems

Notes

Key Systems

Notes

Key Systems



ASSA ABLOY

In U.S.

Corbin Russwin
Architectural Hardware
225 Episcopal Road
Berlin, CT 06037
Phone: 800-543-3658
Fax: 800-447-6714
www.corbinrusswin.com

In Canada

ASSA ABLOY Door
Security Solutions Canada
160 Four Valley Drive
Vaughan, Ontario
Canada L4K 4T9
Phone: 800-461-3007
Fax: 905-738-2478
www.assaabloy.ca

For more information regarding Corbin Russwin Locksets, Exit Devices, Door Controls and Key Systems, contact your authorized Corbin Russwin Distributor or Sales Representative.

Corbin Russwin and Design® is a registered trademark of Corbin Russwin, Inc., an ASSA ABLOY Group company. Other products' brand names may be trademarks or registered trademarks of their respective owners and are mentioned for reference purposes only. These materials are protected under US copyright laws. All contents current at time of publication. Corbin Russwin, Inc., an ASSA ABLOY Group company reserves the right to change availability of any item in this catalog, its design, construction, and/or its materials. Copyright © 2001, 2011 Corbin Russwin, Inc., an ASSA ABLOY Group company. All rights reserved. Reproduction in whole or in part without the express written permission of Corbin Russwin, Inc. is prohibited.

ASSA ABLOY is the global leader in door opening solutions, dedicated to satisfying end-user needs for security, safety and convenience.